



85V 4.2mΩ N-Ch Power MOSFET

Features

- Ultra-low $R_{DS(ON)}$
- Low Gate Charge
- High Current Capability
- 100% UIS Tested, 100% R_g Tested

Applications

- Power Management in Telecom., Industrial Automation, CE
- Motor Driving in Power Tool, E-vehicle, Robotics
- Current Switching in DC/DC & AC/DC (SR) Sub-systems

Product Summary

Parameter	Typ.	Unit
V_{DS}	85	V
$V_{GS(th)}$	2.8	V
I_D (@ $V_{GS} = 10V$)	121	A
$R_{DS(ON)}$ (@ $V_{GS} = 10V$)	4.2	mΩ

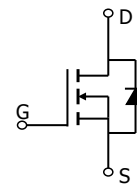
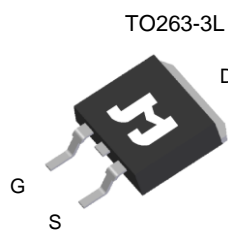
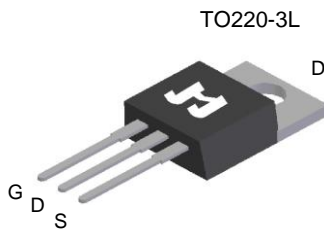

Ordering information

Device	Package	# of Pins	Marking	MSL	T_J (°C)	Media	Quantity (pcs)
JMSH0805AC-U	TO220-3L	3	SH0805A	N/A	-55 to 150	Tube	50
JMSH0805AE-13	TO263-3L	3	SH0805A	3	-55 to 150	13-inch Reel	800

Absolute Maximum Ratings (@ $T_A = 25^\circ\text{C}$ unless otherwise specified)

Parameter	Symbol	Value	Unit
Drain-to-Source Voltage	V_{DS}	85	V
Gate-to-Source Voltage	V_{GS}	± 20	V
Continuous Drain Current	I_D	$T_C = 25^\circ\text{C}$	121
		$T_C = 70^\circ\text{C}$	96
Pulsed Drain Current	I_{DM}	484	A
Avalanche Current	I_{AS}	48	A
Avalanche Energy (@ $L = 0.1\text{mH}$)	E_{AS}	115	mJ
Power Dissipation	P_D	$T_C = 25^\circ\text{C}$	130
		$T_C = 70^\circ\text{C}$	83
Junction & Storage Temperature Range	T_J, T_{STG}	-55 to 150	°C

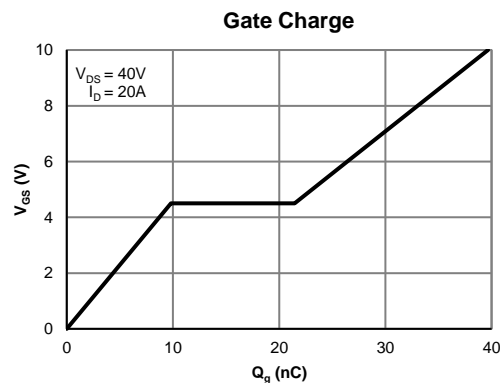
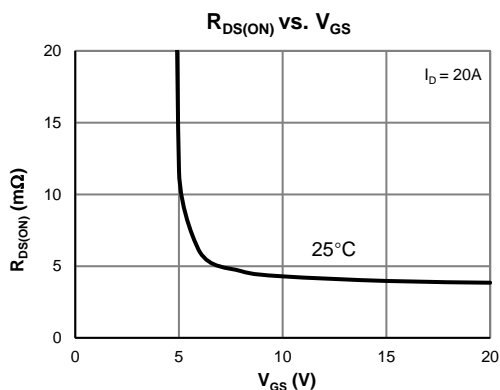



Electrical Characteristics (@ $T_j = 25^\circ\text{C}$ unless otherwise specified)

Parameter	Symbol	Conditions	Min.	Typ.	Max.	Unit
STATIC PARAMETERS						
Drain-Source Breakdown Voltage	$V_{(BR)DSS}$	$I_D = 250\mu\text{A}, V_{GS} = 0\text{V}$	85			V
Zero Gate Voltage Drain Current	I_{DSS}	$V_{DS} = 68\text{V}, V_{GS} = 0\text{V}$ $T_j = 55^\circ\text{C}$			1	μA
					5	
Gate-Body Leakage Current	I_{GSS}	$V_{DS} = 0\text{V}, V_{GS} = \pm 20\text{V}$			± 100	nA
Gate Threshold Voltage	$V_{GS(th)}$	$V_{DS} = V_{GS}, I_D = 250\mu\text{A}$	2.0	2.8	4.0	V
Static Drain-Source ON-Resistance	$R_{DS(ON)}$	$V_{GS} = 10\text{V}, I_D = 20\text{A}$		4.2	5.0	$\text{m}\Omega$
Forward Transconductance	g_{FS}	$V_{DS} = 5\text{V}, I_D = 20\text{A}$		55		S
Diode Forward Voltage	V_{SD}	$I_S = 1\text{A}, V_{GS} = 0\text{V}$		0.7	1.0	V
Diode Continuous Current	I_S	$T_C = 25^\circ\text{C}$			130	A

DYNAMIC PARAMETERS

Input Capacitance	C_{iss}	$V_{GS} = 0\text{V}, V_{DS} = 40\text{V}, f = 1\text{MHz}$		2451		pF
Output Capacitance	C_{oss}			677		pF
Reverse Transfer Capacitance	C_{rss}			18		pF
Gate Resistance	R_g	$V_{GS} = 0\text{V}, V_{DS} = 0\text{V}, f = 1\text{MHz}$		1.5		Ω

SWITCHING PARAMETERS

Total Gate Charge (@ $V_{GS} = 10\text{V}$)	Q_g	$V_{GS} = 0 \text{ to } 10\text{V}, V_{DS} = 40\text{V},$ $I_D = 20\text{A}$		39.7		nC
Total Gate Charge (@ $V_{GS} = 6\text{V}$)	Q_g			26.4		nC
Gate Source Charge	Q_{gs}			9.8		nC
Gate Drain Charge	Q_{gd}			11.6		nC
Turn-On DelayTime	$t_{D(on)}$	$V_{GS} = 10\text{V}, V_{DS} = 40\text{V}$ $R_L = 2.0\Omega, R_{GEN} = 6\Omega$		15.3		ns
Turn-On Rise Time	t_r			35.4		ns
Turn-Off DelayTime	$t_{D(off)}$			33.2		ns
Turn-Off Fall Time	t_f			22.4		ns
Body Diode Reverse Recovery Time	t_{rr}	$I_F = 20\text{A}, dI_F/dt = 100\text{A}/\mu\text{s}$		47.5		ns
Body Diode Reverse Recovery Charge	Q_{rr}	$I_F = 20\text{A}, dI_F/dt = 100\text{A}/\mu\text{s}$		81.6		nC

Thermal Performance

Parameter	Symbol	Typ.	Max.	Unit
Thermal Resistance, Junction-to-Ambient	$R_{\theta JA}$	45	55	$^\circ\text{C}/\text{W}$
Thermal Resistance, Junction-to-Case	$R_{\theta JC}$	0.8	1.0	$^\circ\text{C}/\text{W}$

Typical Electrical & Thermal Characteristics

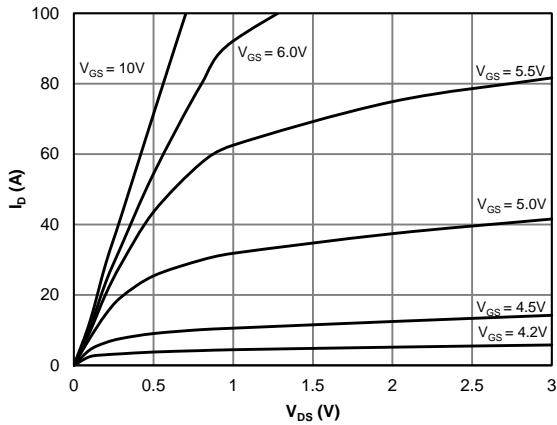

Figure 1: Saturation Characteristics

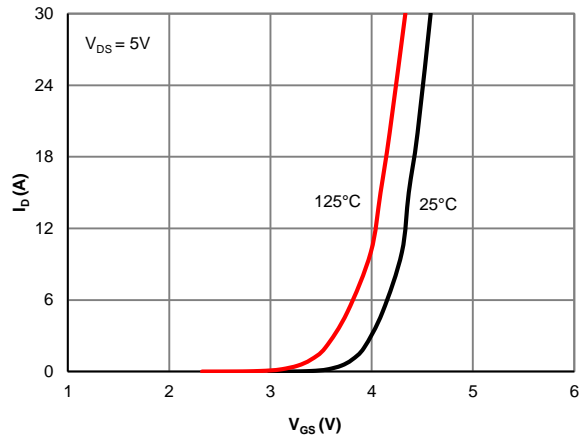

Figure 2: Transfer Characteristics

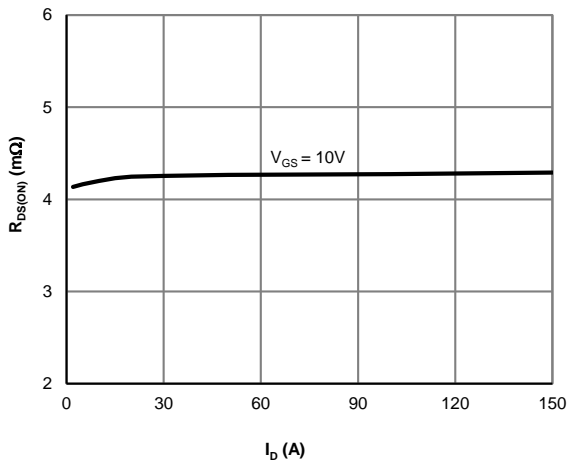

Figure 3: $R_{DS(on)}$ vs. Drain Current

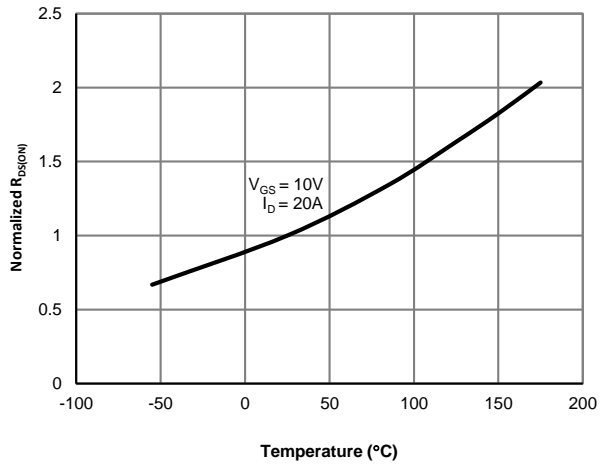

Figure 4: $R_{DS(on)}$ vs. Junction Temperature

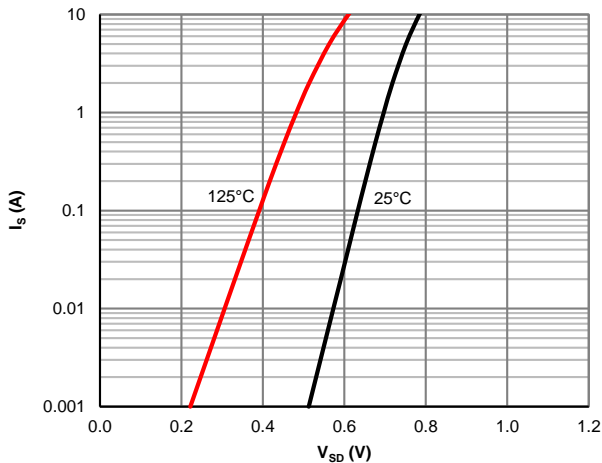

Figure 5: Body-Diode Characteristics

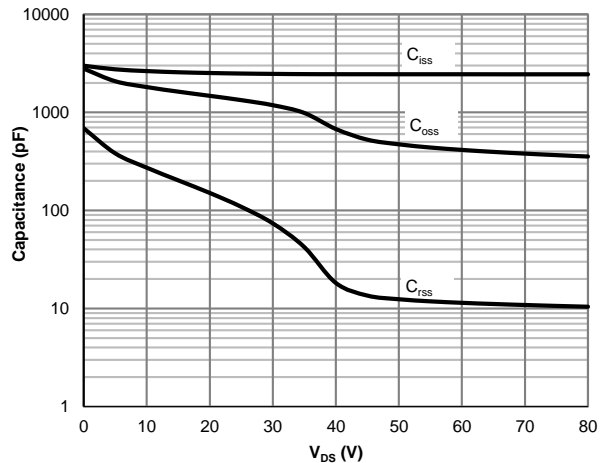

Figure 6: Capacitance Characteristics

Typical Electrical & Thermal Characteristics

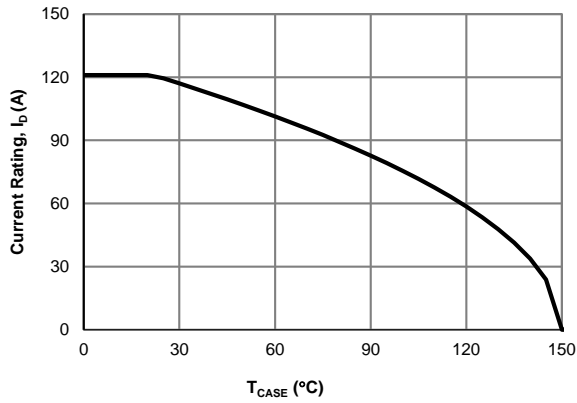

Figure 7: Current De-rating

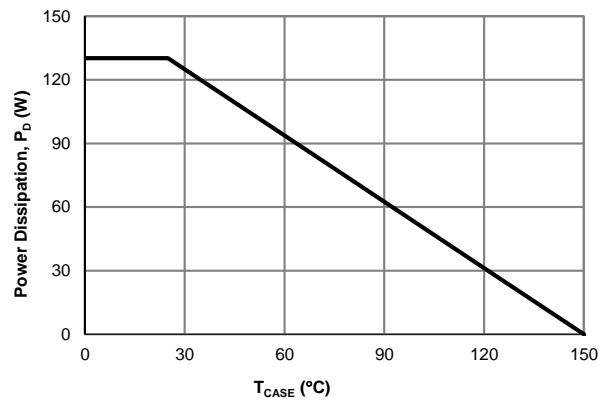

Figure 8: Power De-rating

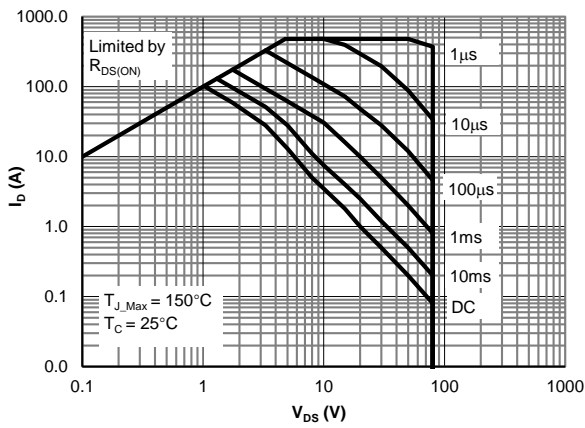

Figure 9: Maximum Safe Operating Area

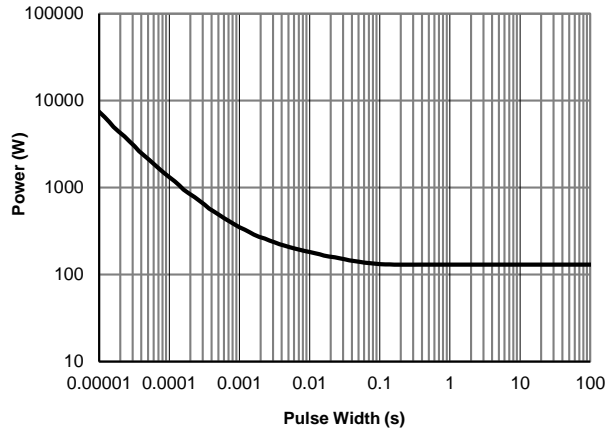

Figure 10: Single Pulse Power Rating, Junction-to-Case

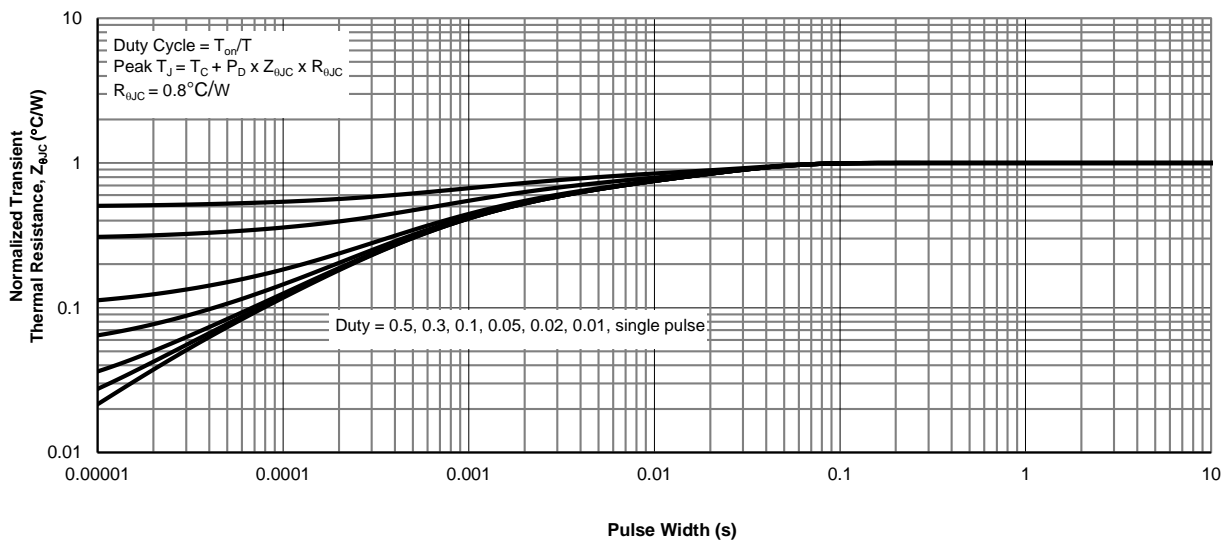
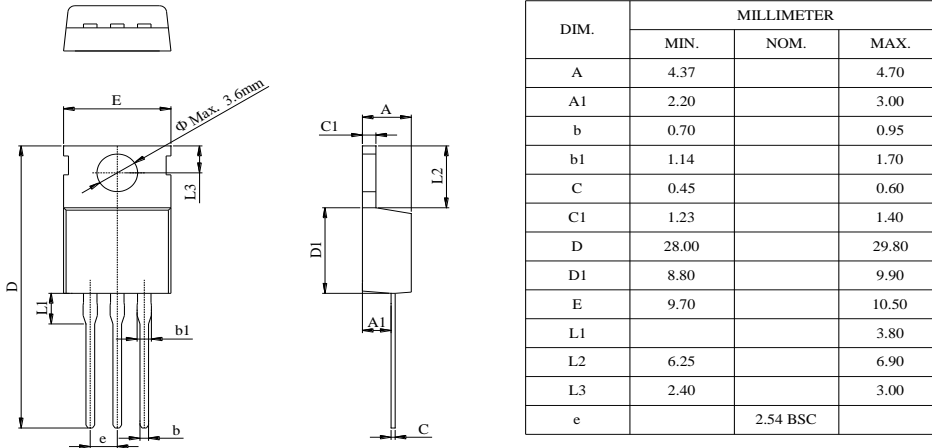

Figure 11: Normalized Maximum Transient Thermal Impedance

TO220-3L Package Information (All units in mm)

Package Outline



TO263-3L Package Information (All units in mm)

Package Outline

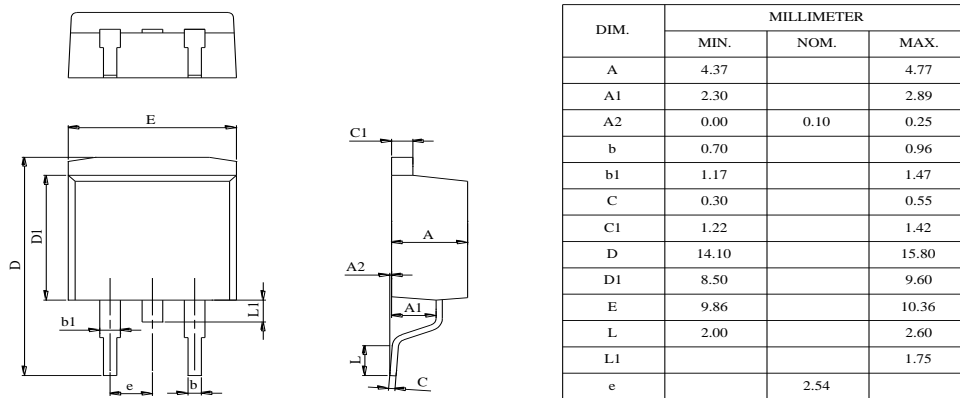

Recommended Footprint

