



40V 5.7mΩ N-Ch Power MOSFET

Features

- Ultra-low $R_{DS(ON)}$
- Low Gate Charge
- High Current Capability
- 100% UIS Tested, 100% R_g Tested

Product Summary

Parameter	Typ.	Unit
V_{DS}	40	V
$V_{GS(th)}$	1.7	V
I_D (@ $V_{GS} = 10V$) ⁽¹⁾	43	A
$R_{DS(ON)}$ (@ $V_{GS} = 10V$)	5.7	mΩ

Applications

- Power Management in Computing, CE, IE 4.0, Communications
- Current Switching in DC/DC & AC/DC (SR) Sub-systems
- Load Switching, Quick/Wireless Charging, Motor Driving

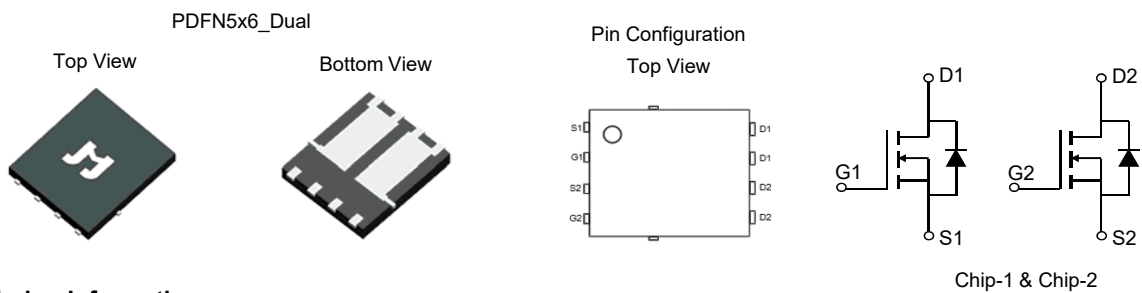

Ordering Information

Device	Package	# of Pins	Marking	MSL	T_J (°C)	Media	Quantity (pcs)
JMSL0406AGD-13	PDFN5x6_Dual	8	L0406AD	1	-55 to 150	13-inch Reel	3000

Absolute Maximum Ratings (@ $T_A = 25^\circ C$ unless otherwise specified)

Parameter	Symbol	Value	Unit
Drain-to-Source Voltage	V_{DS}	40	V
Gate-to-Source Voltage	V_{GS}	± 20	V
Continuous Drain Current ⁽¹⁾	I_D	$T_C = 25^\circ C$	43
		$T_C = 100^\circ C$	27
Pulsed Drain Current ⁽²⁾	I_{DM}	158	A
Avalanche Current ⁽³⁾	I_{AS}	21	A
Avalanche Energy ⁽³⁾	E_{AS}	22	mJ
Power Dissipation ⁽⁴⁾	P_D	$T_C = 25^\circ C$	20
		$T_C = 100^\circ C$	8.1
Junction & Storage Temperature Range	T_J, T_{STG}	-55 to 150	°C

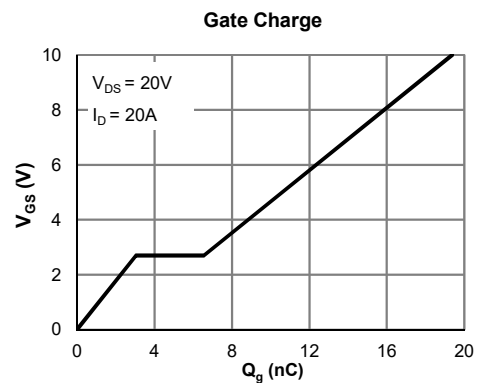
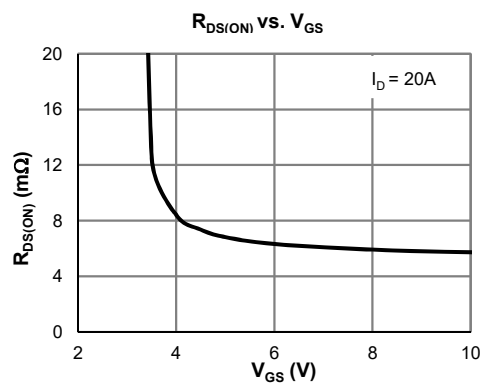

**Electrical Characteristics** (@ $T_J = 25^\circ\text{C}$ unless otherwise specified)

Parameter	Symbol	Conditions	Min.	Typ.	Max.	Unit
STATIC PARAMETERS						
Drain-Source Breakdown Voltage	$V_{(BR)DSS}$	$I_D = 250\mu\text{A}$, $V_{GS} = 0\text{V}$	40			V
Zero Gate Voltage Drain Current	I_{DSS}	$V_{DS} = 32\text{V}$, $V_{GS} = 0\text{V}$ $T_J = 55^\circ\text{C}$			1.0 5.0	μA
Gate-Body Leakage Current	I_{GSS}	$V_{DS} = 0\text{V}$, $V_{GS} = \pm 20\text{V}$			± 100	nA
Gate Threshold Voltage	$V_{GS(th)}$	$V_{DS} = V_{GS}$, $I_D = 250\mu\text{A}$	1.2	1.7	2.5	V
Static Drain-Source ON-Resistance	$R_{DS(on)}$	$V_{GS} = 10\text{V}$, $I_D = 20\text{A}$		5.7	6.9	$\text{m}\Omega$
		$V_{GS} = 4.5\text{V}$, $I_D = 15\text{A}$		7.2	9.5	$\text{m}\Omega$
Forward Transconductance	g_{FS}	$V_{DS} = 5\text{V}$, $I_D = 20\text{A}$		95		S
Diode Forward Voltage	V_{SD}	$I_S = 1\text{A}$, $V_{GS} = 0\text{V}$		0.71	1.0	V
Diode Continuous Current	I_S	$T_C = 25^\circ\text{C}$			20	A
DYNAMIC PARAMETERS ⁽⁵⁾						
Input Capacitance	C_{iss}	$V_{GS} = 0\text{V}$, $V_{DS} = 20\text{V}$, $f = 1\text{MHz}$		1227		pF
Output Capacitance	C_{oss}			526		pF
Reverse Transfer Capacitance	C_{rss}			55		pF
Gate Resistance	R_g	$V_{GS} = 0\text{V}$, $V_{DS} = 0\text{V}$, $f = 1\text{MHz}$		2.7		Ω
SWITCHING PARAMETERS ⁽⁵⁾						
Total Gate Charge (@ $V_{GS} = 10\text{V}$)	Q_g	$V_{GS} = 0$ to 10V $V_{DS} = 20\text{V}$, $I_D = 20\text{A}$		19.4		nC
Total Gate Charge (@ $V_{GS} = 4.5\text{V}$)	Q_g			9.7		nC
Gate Source Charge	Q_{gs}			3.1		nC
Gate Drain Charge	Q_{gd}			3.5		nC
Turn-On Delay Time	$t_{D(on)}$	$V_{GS} = 10\text{V}$, $V_{DS} = 20\text{V}$ $R_L = 1.0\Omega$, $R_{GEN} = 6\Omega$		5.0		ns
Turn-On Rise Time	t_r			7.0		ns
Turn-Off Delay Time	$t_{D(off)}$			23		ns
Turn-Off Fall Time	t_f			14.8		ns
Body Diode Reverse Recovery Time	t_{rr}		$I_F = 15\text{A}$, $dI_F/dt = 100\text{A}/\mu\text{S}$		26	
Body Diode Reverse Recovery Charge	Q_{rr}	$I_F = 15\text{A}$, $dI_F/dt = 100\text{A}/\mu\text{S}$		14.0		nC

Thermal Performance

Parameter	Symbol	Typ.	Max.	Unit
Thermal Resistance, Junction-to-Ambient	$R_{\theta JA}$	50	60	$^\circ\text{C}/\text{W}$
Thermal Resistance, Junction-to-Case	$R_{\theta JC}$	5.1	6.2	$^\circ\text{C}/\text{W}$

Notes:

1. Computed continuous current assumes the condition of T_{J_Max} while the actual continuous current depends on the thermal & electro-mechanical application board design.
2. This single-pulse measurement was taken under $T_{J_Max} = 150^\circ\text{C}$.
3. This single-pulse measurement was taken under the following condition [$L = 100\mu\text{H}$, $V_{GS} = 10\text{V}$, $V_{DS} = 20\text{V}$] while its value is limited by $T_{J_Max} = 150^\circ\text{C}$.
4. The power dissipation P_D is based on $T_{J_Max} = 150^\circ\text{C}$.
5. This value is guaranteed by design hence it is not included in the production test.

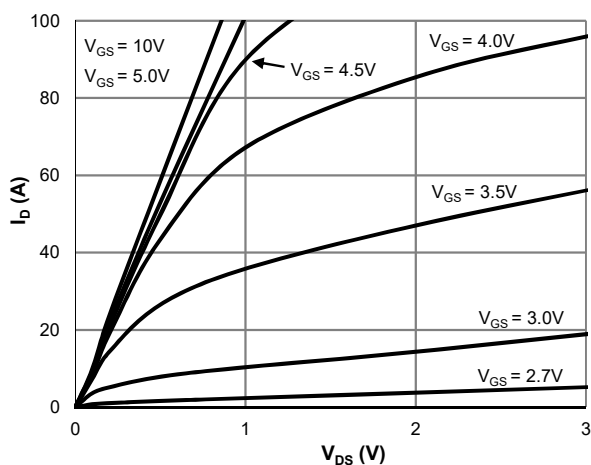
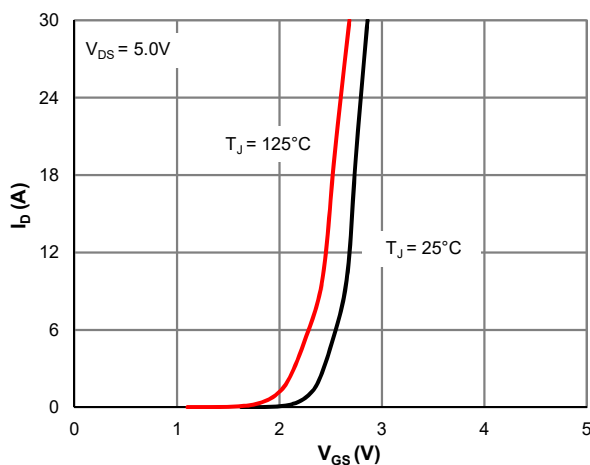
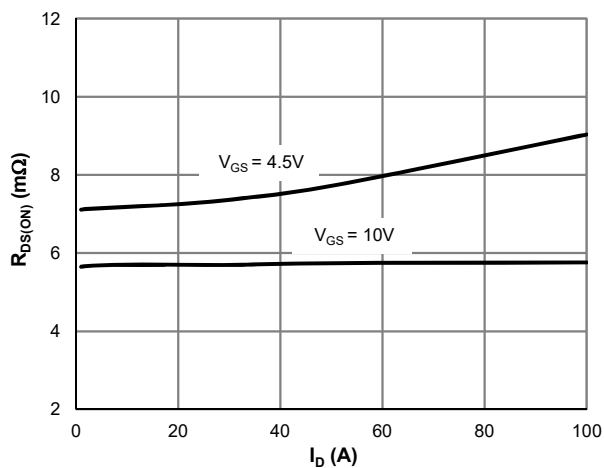
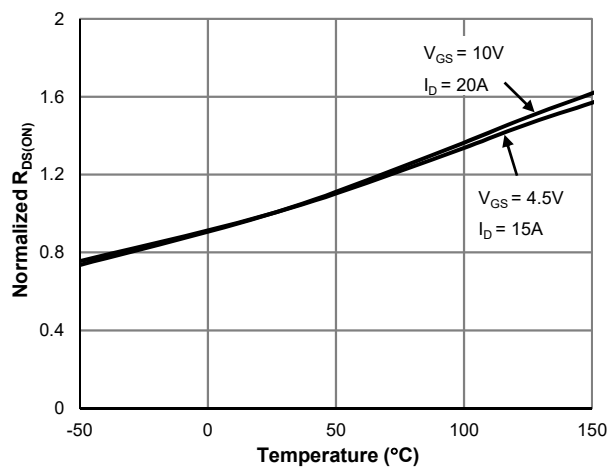
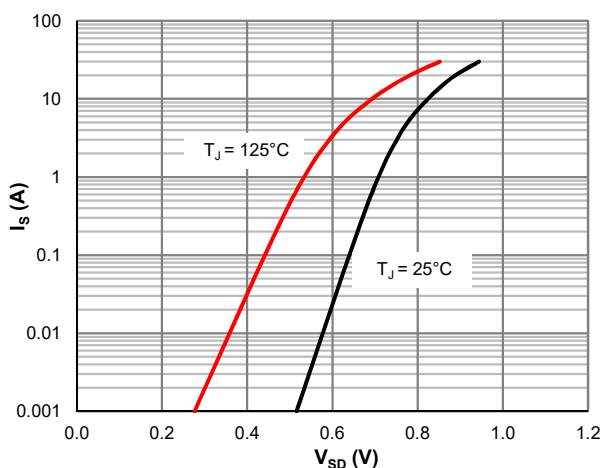
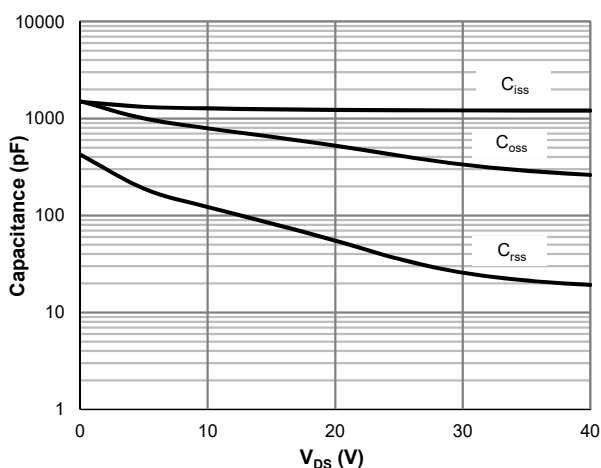
Typical Electrical & Thermal Characteristics

Figure 1: Saturation Characteristics

Figure 2: Transfer Characteristics

Figure 3: $R_{DS(ON)}$ vs. Drain Current

Figure 4: $R_{DS(ON)}$ vs. Junction Temperature

Figure 5: Body-Diode Characteristics

Figure 6: Capacitance Characteristics



Typical Electrical & Thermal Characteristics

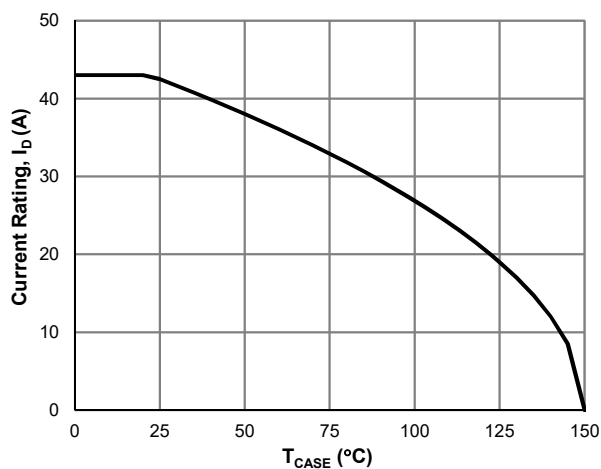

Figure 7: Current De-rating

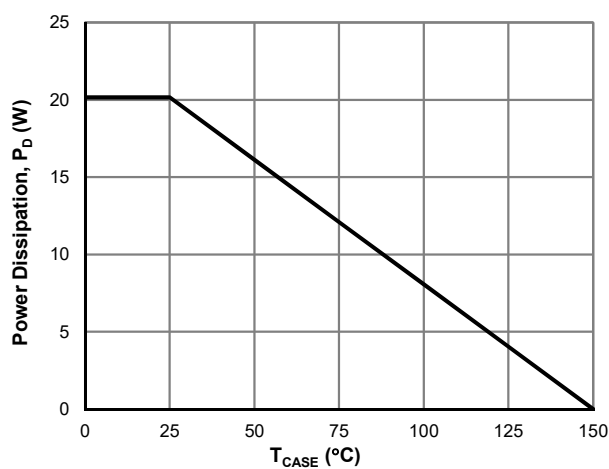

Figure 8: Power De-rating

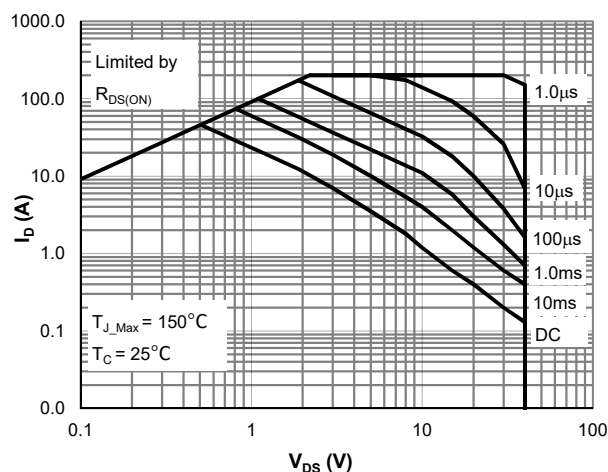

Figure 9: Maximum Safe Operating Area

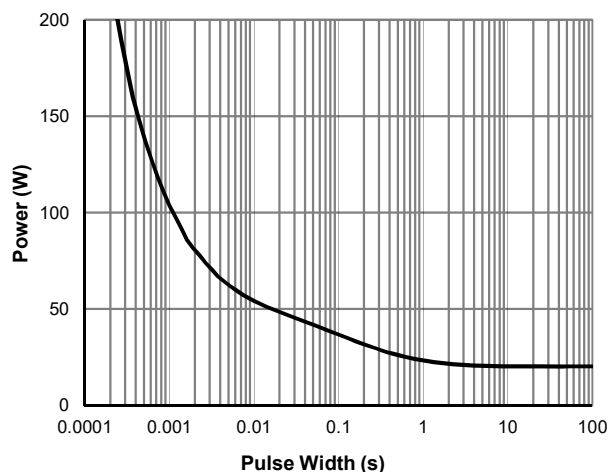

Figure 10: Single Pulse Power Rating, Junction-to-Case

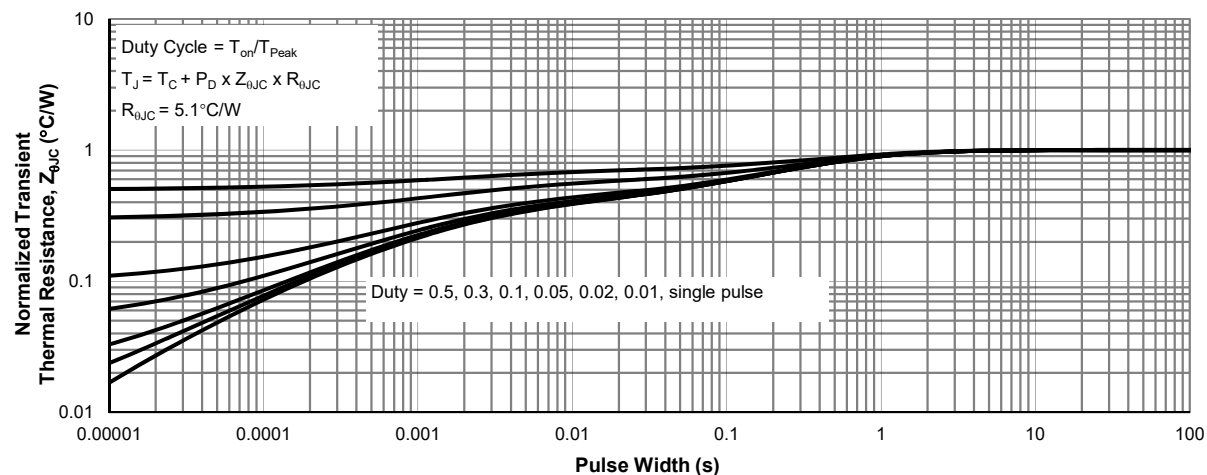
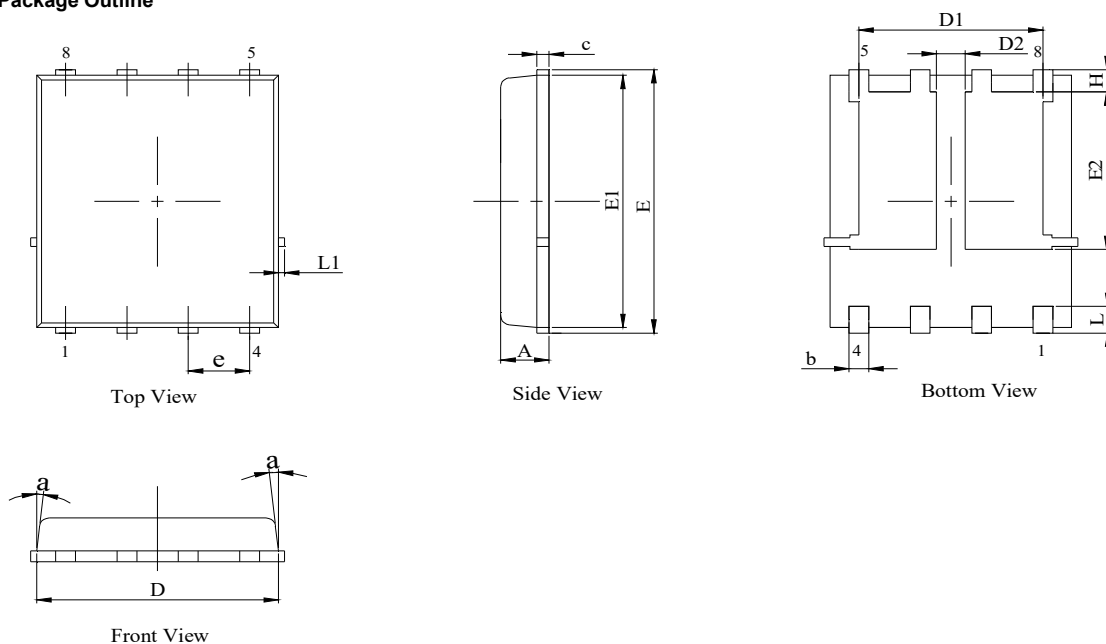
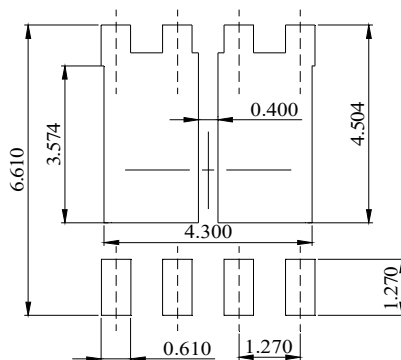

Figure 11: Normalized Maximum Transient Thermal Impedance

PDFN5x6_Dual Package Information
Package Outline

NOTES:

1. Dimension and tolerance per ASME Y14.5M, 1994.
2. All dimensions in millimeter (angle in degree).
3. Dimensions D and E1 do not include mold flash protrusions or gate burrs.

DIM.	MILLIMETER	
	MIN.	MAX.
A	0.90	1.10
b	0.33	0.51
c	0.23	0.33
D	4.80	5.40
D1	3.61	4.25
D2	0.50	0.70
E	5.90	6.25
E1	5.55	5.80
E2	3.35	3.78
e	1.27 BSC	
H	0.41	0.80
L	0.51	0.80
L1		0.15
a	0°	12°

Recommended Footprint

DIMENSIONS: MILLIMETERS