



### DESCRIPTION:

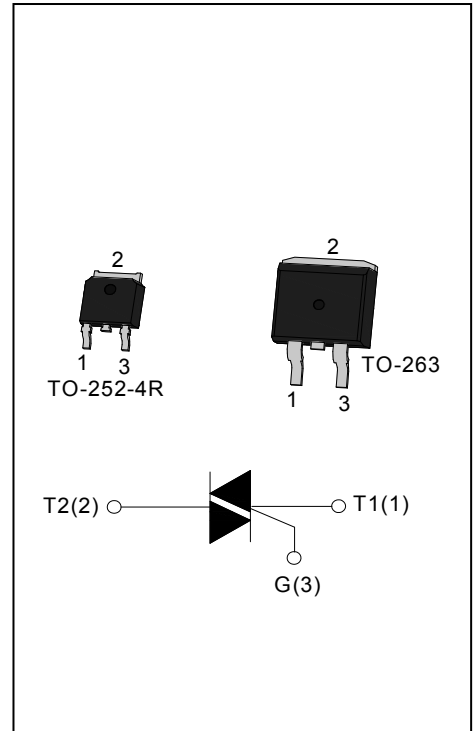
T04xxH series triacs of high junction temperature with high dv/dt rate with strong resistance to electromagnetic interference provide high ability to withstand the shock loading of large current. They are especially recommended for use on inductive load and high environment temperature condition.

Package TO-252-4R & TO-263 are RoHS compliant.

(2011/65/EU)

### MAIN FEATURES

Symbol	Value	Unit
$I_{T(RMS)}$	4	A
$V_{DRM} / V_{RRM}$	600/800	V
$T_{jmax}$	150	°C



### ABSOLUTE MAXIMUM RATINGS

Parameter	Symbol	Value	Unit
Storage junction temperature range	$T_{stg}$	-40 - 150	°C
Operating junction temperature range	$T_j$	-40 - 150	°C
Repetitive peak off-state voltage ( $T_j=25^\circ\text{C}$ )	$V_{DRM}$	600/800	V
Repetitive peak reverse voltage ( $T_j=25^\circ\text{C}$ )	$V_{RRM}$	600/800	V
RMS on-state current	TO-252-4R ( $T_c=135^\circ\text{C}$ )	4	A
	TO-263 ( $T_c=130^\circ\text{C}$ )		
Non repetitive surge peak on-state current (full cycle, $F=50\text{Hz}$ )	$I_{TSM}$	40	A
$I^2t$ value for fusing ( $t_p=10\text{ms}$ )	$I^2t$	8	$\text{A}^2\text{s}$
Critical rate of rise of on-state current ( $I_G = 2 \times I_{GT}$ )	$dI/dt$	50	$\text{A}/\mu\text{s}$
Peak gate current	$I_{GM}$	2	A
Average gate power dissipation	$P_{G(AV)}$	1	W
Peak gate power	$P_{GM}$	5	W

ELECTRICAL CHARACTERISTICS ( $T_j=25^{\circ}\text{C}$  unless otherwise specified)

Symbol	Test Condition	Quadrant		Value				Unit
				T0410H	T0420H	T0435H	T0450H	
$I_{GT}$	$V_D=12\text{V } R_L=33\Omega$	I - II - III	MAX	10	20	35	50	mA
$V_{GT}$		I - II - III	MAX	1.3				V
$V_{GD}$	$V_D=V_{DRM} T_j=150^{\circ}\text{C}$ $R_L=3.3\text{K}\Omega$	I - II - III	MIN	0.2				V
$I_L$	$I_G=1.2I_{GT}$	I - III	MAX	20	40	50	70	mA
		II		35	55	70	80	
$I_H$	$I_T=100\text{mA}$		MAX	20	30	45	60	mA
dV/dt	$V_D=2/3V_{DRM}$ Gate Open $T_j=150^{\circ}\text{C}$		MIN	200	500	1000	1500	V/ $\mu\text{s}$

## STATIC CHARACTERISTICS

Symbol	Parameter		Value(MAX)	Unit
$V_{TM}$	$I_{TM}=5.5\text{A } t_p=380\mu\text{s}$	$T_j=25^{\circ}\text{C}$	1.4	V
$I_{DRM}$	$V_D=V_{DRM} V_R=V_{RRM}$	$T_j=25^{\circ}\text{C}$	5	$\mu\text{A}$
$I_{RRM}$		$T_j=150^{\circ}\text{C}$	0.5	mA

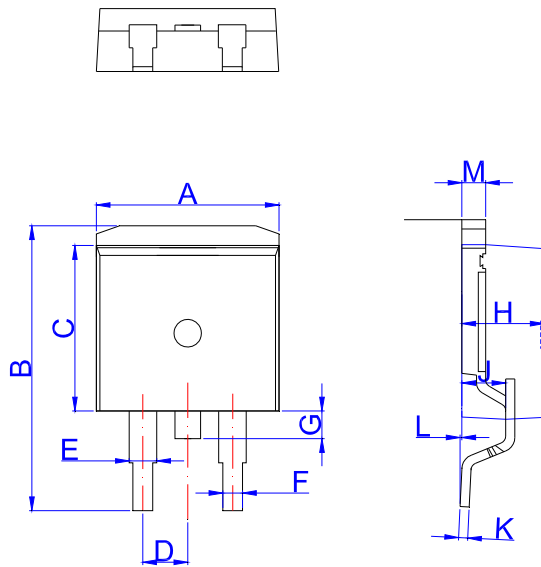
## THERMAL RESISTANCES

Symbol	Parameter		Value	Unit
$R_{th(j-c)}$	junction to case(AC)	TO-252-4R	2.8	$^{\circ}\text{C/W}$
		TO-263	3.5	
$R_{th(j-a)}$	junction to ambient	TO-252-4R	70	$^{\circ}\text{C/W}$
		TO-263	45	

ORDERING INFORMATION

<p><b>T</b></p> <p>Triacs</p> <p><b>04</b></p> <p><math>I_{T(RMS)}:4A</math></p> <p>10: <math>I_{GT1-3} \leq 10mA</math></p> <p>20: <math>I_{GT1-3} \leq 20mA</math></p> <p>35: <math>I_{GT1-3} \leq 35mA</math></p> <p>50: <math>I_{GT1-3} \leq 50mA</math></p>	<p><b>20</b></p>	<p><b>H</b></p>	<p><b>-6</b></p> <p>6: <math>V_{DRM} / V_{RRM} \geq 600V</math></p> <p>8: <math>V_{DRM} / V_{RRM} \geq 800V</math></p> <p>High junction temperature</p>	<p><b>E</b></p> <p>E: TO-263</p> <p>ETR: TO-263(Tape&amp;Reel)</p> <p>K: TO-252-4R</p> <p>KTR: TO-252-4R(Tape&amp;Reel)</p>
--	------------------	-----------------	---	---

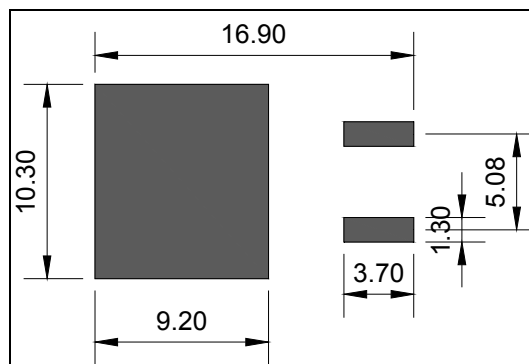
PACKAGE MECHANICAL DATA



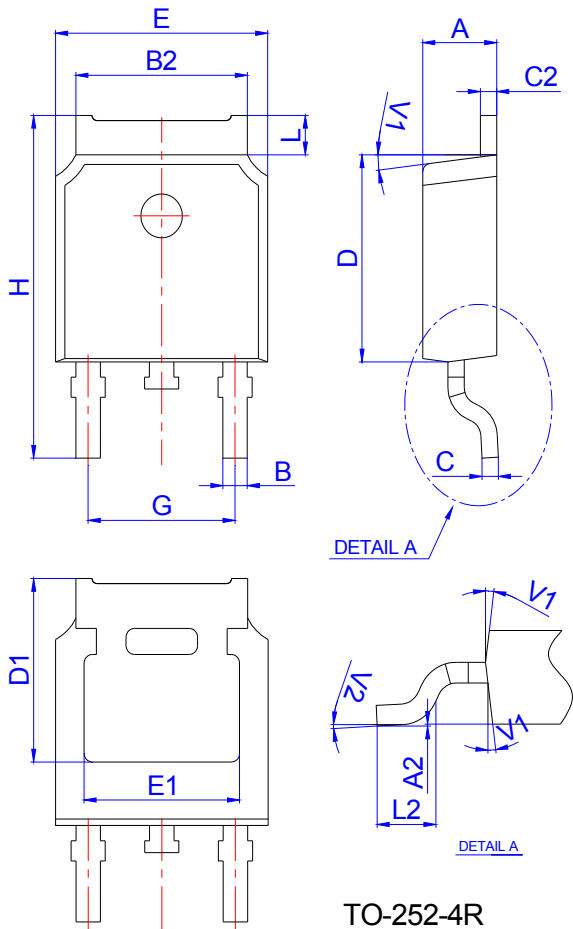
TO-263

Ref.	Dimensions					
	Millimeters			Inches		
	Min.	Typ.	Max.	Min.	Typ.	Max.
A	9.90		10.20	0.390		0.402
B	14.70		15.80	0.579		0.622
C	9.4		9.6	0.37		0.378
D		2.54			0.100	
E	1.20		1.40	0.047		0.055
F	0.75		0.85	0.029		0.033
G			1.75			0.069
H	4.40		4.70	0.173		0.185
J	2.30		2.70	0.091		0.106
K	0.38		0.55	0.015		0.022
L	0	0.10	0.25	0	0.004	0.010
M	1.25		1.35	0.049		0.053

FOOTPRINT-TO-263 (dimensions in mm)

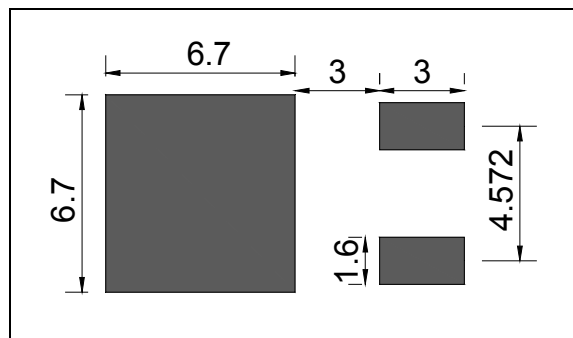


PACKAGE MECHANICAL DATA

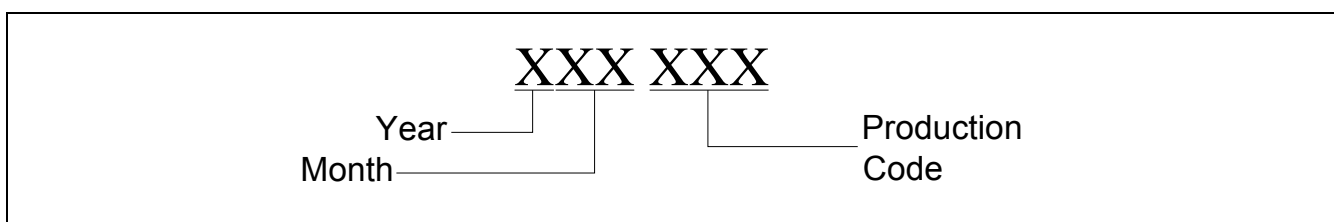
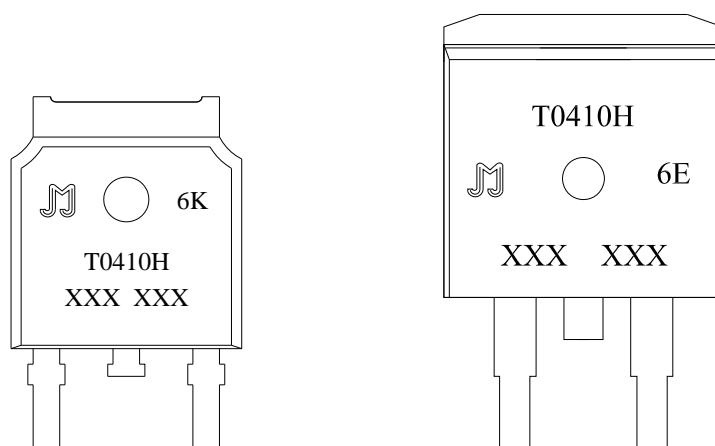


Ref.	Dimensions					
	Millimeters			Inches		
	Min.	Typ.	Max.	Min.	Typ.	Max.
A	2.10		2.50	0.083		0.098
A2	0		0.10	0		0.004
B	0.66		0.86	0.026		0.034
B2	5.18		5.48	0.202		0.216
C	0.40		0.60	0.016		0.024
C2	0.44		0.58	0.017		0.023
D	5.90		6.30	0.232		0.248
D1	5.30REF			0.209REF		
E	6.40		6.80	0.252		0.268
E1	4.63			0.182		
G	4.47		4.67	0.176		0.184
H	9.50		10.70	0.374		0.421
L	1.09		1.21	0.043		0.048
L2	1.35		1.65	0.053		0.065
V1		7°			7°	
V2	0°		6°	0°		6°

FOOTPRINT-TO-252-4R (dimensions in mm)



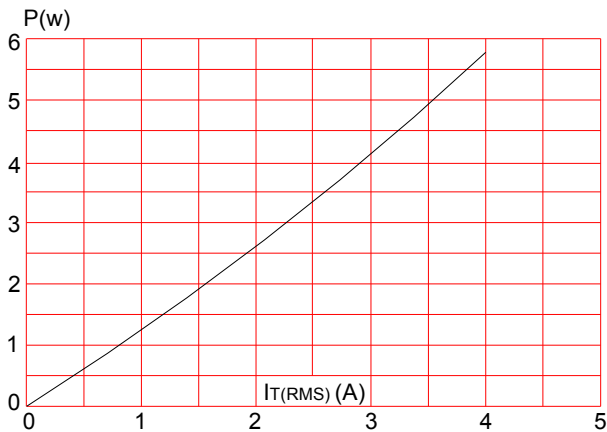
MARKING



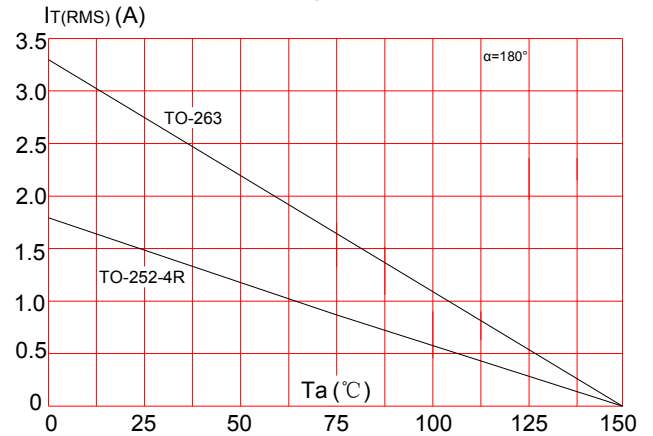
PACKAGE INFORMATION

PACKAGE	OUTLINE	TUBE (PCS)	INNER BOX (PCS)	PER CARTON
TO-263	TUBE	50	1,000	6,000
TO-252-4R	TUBE	80	4,000	32,000
PACKAGE	OUTLINE	REEL (PCS)	PER CARTON (PCS)	TAPE & REEL
TO-263	TAPING	800	4,000	13 inch
TO-252-4R	TAPING	2,500	25,000	13 inch

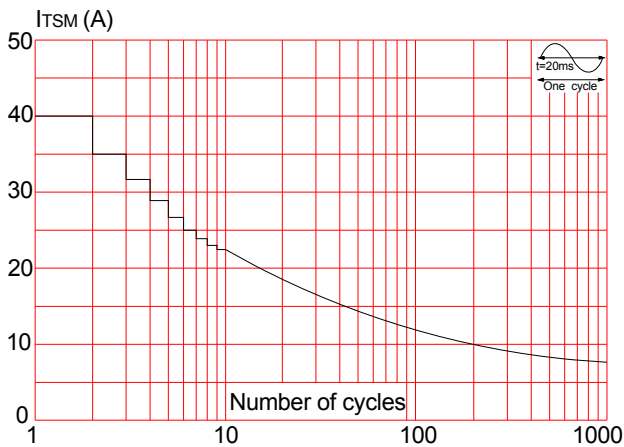
**FIG.1:** Maximum power dissipation versus RMS on-state current



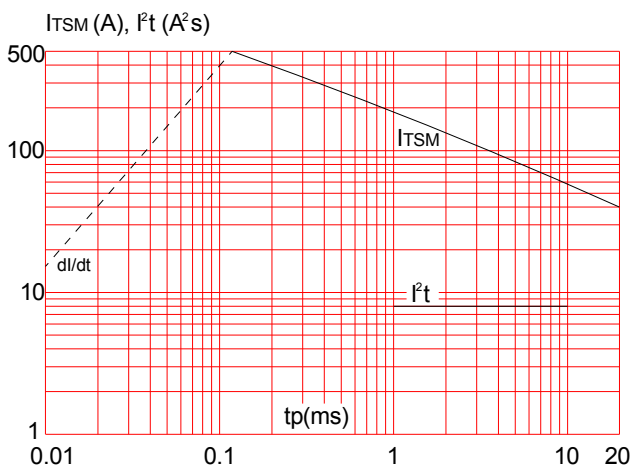
**FIG.2:** RMS on-state current versus ambient temperature (printed circuit board FR4, copper thickness:35μm)(full cycle)



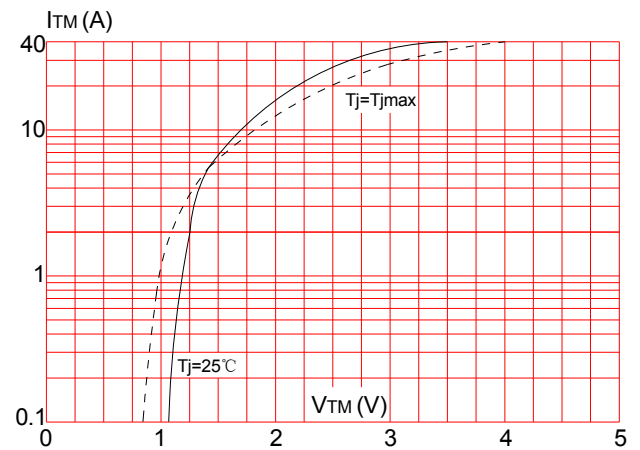
**FIG.3:** Surge peak on-state current versus number of cycles



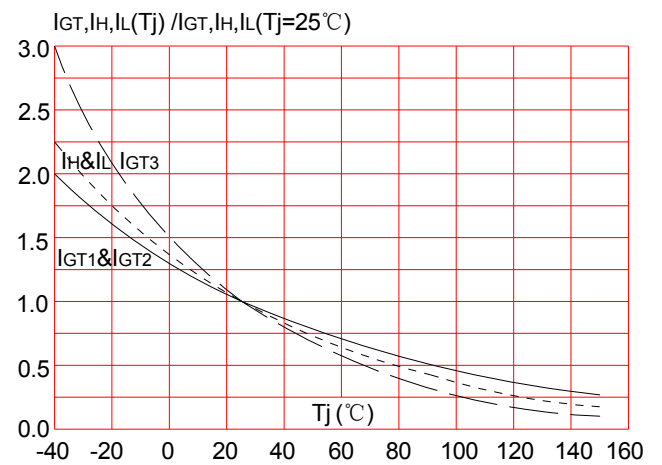
**FIG.5:** Non-repetitive surge peak on-state current for a sinusoidal pulse with width  $t_p < 20\text{ms}$ , and corresponding value of  $I^2t$  ( $di/dt < 50\text{A}/\mu\text{s}$ )



**FIG.4:** On-state characteristics (maximum values)

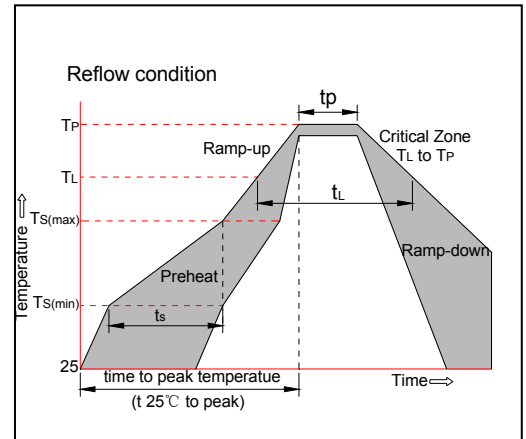


**FIG.6:** Relative variations of gate trigger current, holding current and latching current versus junction temperature



**SOLDERING PARAMETERS**

Reflow Condition		Pb-Free assembly (see figure at right)
Pre Heat	-Temperature Min ( $T_{s(min)}$ )	+150°C
	-Temperature Max( $T_{s(max)}$ )	+200°C
	-Time (Min to Max) (ts)	60-180 secs.
Average ramp up rate (Liquidus Temp ( $T_L$ )to peak)		3°C/sec. Max
$T_{s(max)}$ to $T_L$ - Ramp-up Rate		3°C/sec. Max
Reflow	-Temperature( $T_L$ )(Liquidus)	+217°C
	-Temperature( $t_L$ )	60-150 secs.
Peak Temp ( $T_P$ )		+260(+0/-5)°C
Time within 5°C of actual Peak Temp ( $t_p$ )		20-40secs.
Ramp-down Rate		6°C/sec. Max
Time 25°C to Peak Temp ( $T_P$ )		8 min. Max
Do not exceed		+260°C




Information furnished in this document is believed to be accurate and reliable. However, Jiangsu JieJie Microelectronics Co.,Ltd assumes no responsibility for the consequences of use without consideration for such information nor use beyond it.

Information mentioned in this document is subject to change without notice, apart from that when an agreement is signed, Jiangsu JieJie complies with the agreement.

Products and information provided in this document have no infringement of patents. Jiangsu JieJie assumes no responsibility for any infringement of other rights of third parties which may result from the use of such products and information.

This document is the tenth version which is made in 11-Apr.-2019. This document supersedes and replaces all information previously supplied.

 is a registered trademark of Jiangsu JieJie Microelectronics Co.,Ltd.

Copyright ©2019 Jiangsu JieJie Microelectronics Co.,Ltd. Printed All rights reserved.