



ACJT4 Series 4A TRIACs

Rev.11.0

DESCRIPTION:

The ACJT4 series of double mesa technology provide high interference immunity, They can be used as an static ON/OFF function in electrical control system, and used as a driver of low power and high inductance or resistive loads, such as jet pumps of dishwashers, fans of air-conditioner ...

Package SOT-223 & TO-252-4R are RoHS compliant.

(2011/65/EU)

MAIN FEATURES

Symbol	Value	Unit
$I_{T(RMS)}$	4	A
V_{DRM}/V_{RRM}	800/1000	V
I_{GT}	≤ 5 or ≤ 10 or ≤ 25	mA

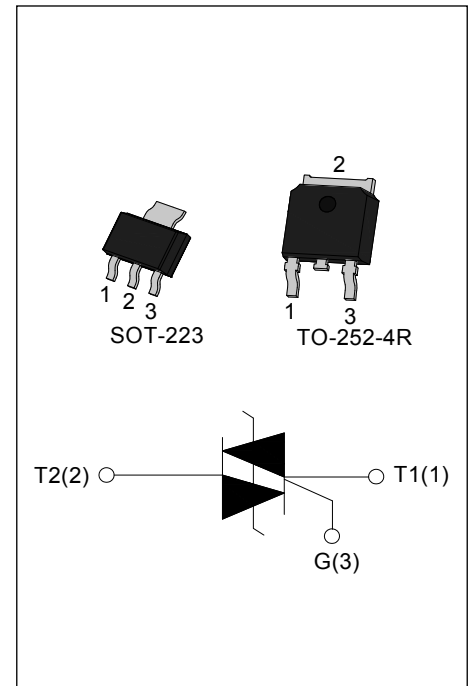

ABSOLUTE MAXIMUM RATINGS

Parameter	Symbol	Value	Unit	
Storage junction temperature range	T_{stg}	-40-150	°C	
Operating junction temperature range	T_j	-40-125	°C	
Repetitive peak off-state voltage($T_j=25^\circ\text{C}$)	V_{DRM}	800/1000	V	
Repetitive peak reverse voltage($T_j=25^\circ\text{C}$)	V_{RRM}	800/1000	V	
RMS on-state current	TO-252-4R ($T_C=110^\circ\text{C}$)	$I_{T(RMS)}$	4	A
Non repetitive surge peak on-state current (full cycle, F=50Hz)	I_{TSM}	30	A	
I^2t value for fusing ($t_p=10\text{ms}$)	I^2t	4.5	A^2s	
Rate of rise of on-state current ($I_G=2 \times I_{GT}$)	di_T/dt	50	$\text{A}/\mu\text{s}$	
Peak gate current	I_{GM}	1	A	
Average gate power dissipation	$P_{G(AV)}$	0.1	W	
Peak gate power	P_{GM}	1	W	

ELECTRICAL CHARACTERISTICS ($T_j=25^{\circ}\text{C}$ unless otherwise specified)

Symbol	Test Condition	Quadrant		Value			Unit
				ACJT405	ACJT410	ACJT425	
I_{GT}	$V_D=12\text{V } R_L=33\Omega$	I - II -III	MAX	5	10	25	mA
V_{GT}		I - II -III	MAX	1.3	1.4	1.5	V
V_{GD}	$V_D=V_{DRM} T_j=125^{\circ}\text{C}$ $R_L=3.3\text{K}\Omega$	I - II -III	MIN	0.2			V
I_L	$I_G=1.2I_{GT}$	I -III	MAX	15	30	40	mA
		II		20	45	60	
I_H	$I_T=100\text{mA}$		MAX	10	25	35	mA
dV/dt	$V_D=2/3V_{DRM}$ Gate Open $T_j=125^{\circ}\text{C}$		MIN	300	600	1000	V/ μs

STATIC CHARACTERISTICS

Symbol	Parameter		Value(MAX)	Unit
V_{TM}	$I_{TM}=5.6\text{A } t_p=380\mu\text{s}$	$T_j=25^{\circ}\text{C}$	1.55	V
I_{DRM}	$V_D=V_{DRM} V_R=V_{RRM}$	$T_j=25^{\circ}\text{C}$	10	μA
I_{RRM}		$T_j=125^{\circ}\text{C}$	1	mA

THERMAL RESISTANCES

Symbol	Parameter		Value	Unit
$R_{th(j-c)}$	junction to case(AC)	TO-252-4R	2.9	$^{\circ}\text{C/W}$
		SOT-223	5.6	
$R_{th(j-a)}$	junction to ambient	TO-252-4R	70	$^{\circ}\text{C/W}$
		SOT-223	60	

ORDERING INFORMATION

AC AC switch JieJie Microelectronics Co.,Ltd	J Triacs	T $I_T(RMS):4A$	4 $I_{GT1-3} \leq 5mA$ $I_{GT1-3} \leq 10mA$ $I_{GT1-3} \leq 25mA$	05	-8	K V:SOT-223 K:TO-252-4R KTR:TO-252-4R(Tape&Reel)
---	--------------------	---------------------------	--	-----------	-----------	--

PACKAGE MECHANICAL DATA

Ref.	Dimensions					
	Millimeters			Inches		
	Min.	Typ.	Max.	Min.	Typ.	Max.
A	1.5	1.6	1.8	0.059	0.063	0.071
A1	0.01	0.06	0.10	0.001	0.002	0.004
B	2.9	3.0	3.1	0.114	0.118	0.122
B1	0.6	0.7	0.8	0.024	0.028	0.031
C	0.22	0.26	0.32	0.009	0.010	0.013
D	6.3	6.5	6.7	0.248	0.256	0.264
E	3.3	3.5	3.7	0.130	0.138	0.146
F		4.6			0.181	
F1		2.3			0.091	
G	0.7	0.9	1.1	0.028	0.035	0.043
H	1.5	1.75	2.0	0.059	0.069	0.079
J	6.7	7.0	7.3	0.264	0.276	0.287
K	0.8	0.9	1.0	0.031	0.035	0.039

SOT-223

FOOTPRINT-SOT-223 (dimensions in mm)

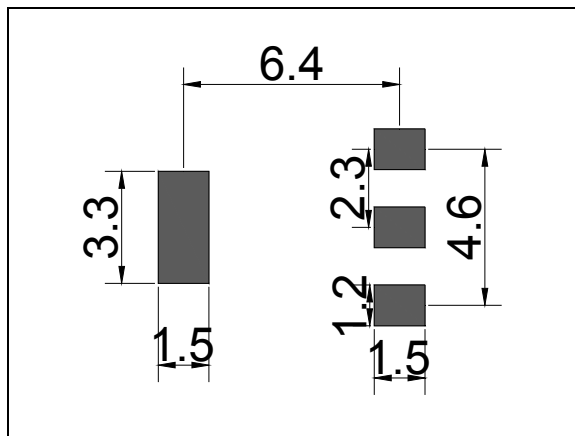

PACKAGE MECHANICAL DATA

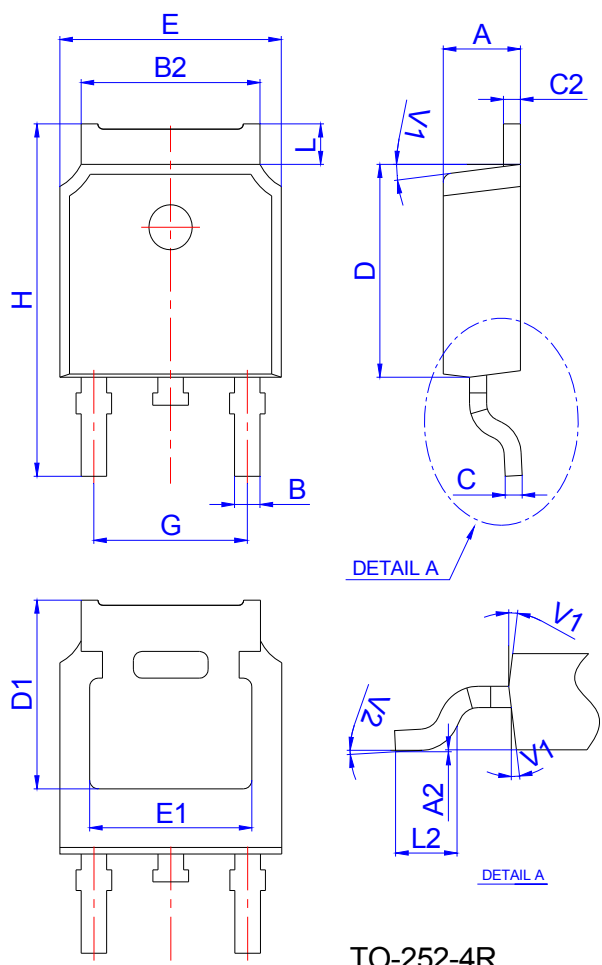

Ref.	Dimensions					
	Millimeters			Inches		
	Min.	Typ.	Max.	Min.	Typ.	Max.
A	2.10		2.50	0.083		0.098
A2	0		0.10	0		0.004
B	0.66		0.86	0.026		0.034
B2	5.18		5.48	0.202		0.216
C	0.40		0.60	0.016		0.024
C2	0.44		0.58	0.017		0.023
D	5.90		6.30	0.232		0.248
D1	5.30REF			0.209REF		
E	6.40		6.80	0.252		0.268
E1	4.63			0.182		
G	4.47		4.67	0.176		0.184
H	9.50		10.70	0.374		0.421
L	1.09		1.21	0.043		0.048
L2	1.35		1.65	0.053		0.065
V1		7°			7°	
V2		0°	6°		0°	6°

FOOTPRINT-TO-252-4R (dimensions in mm)

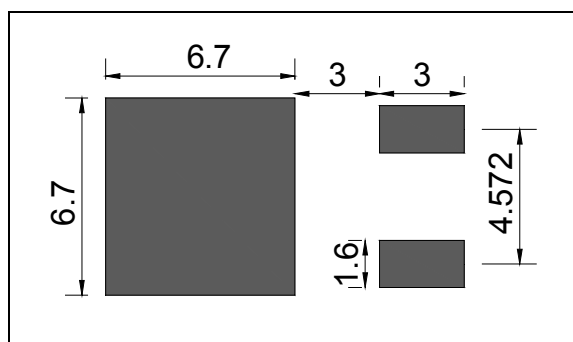

PACKAGE INFORMATION

PACKAGE	OUTLINE	TUBE (PCS)	INNER BOX (PCS)	PER CARTON
TO-252-4R	TUBE	80	4,000	32,000
PACKAGE	OUTLINE	REEL (PCS)	PER CARTON (PCS)	TAPE & REEL
SOT-223	TAPING	4,000	40,000	13 inch
TO-252-4R	TAPING	2,500	25,000	13 inch

FIG.1 Maximum power dissipation versus RMS on-state current

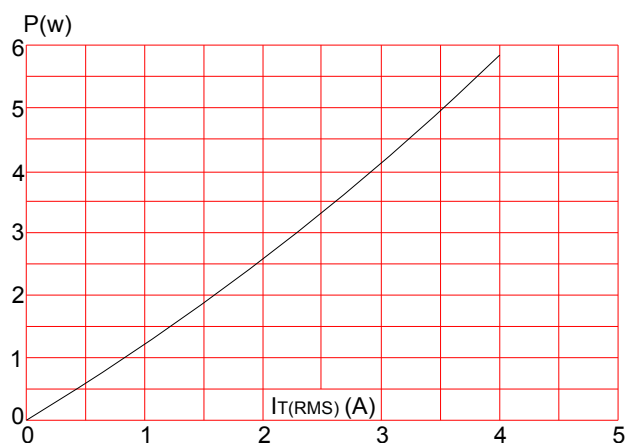

FIG.2: RMS on-state current versus ambient temperature (printed circuit board FR4, copper thickness: 35 μ m)(full cycle)

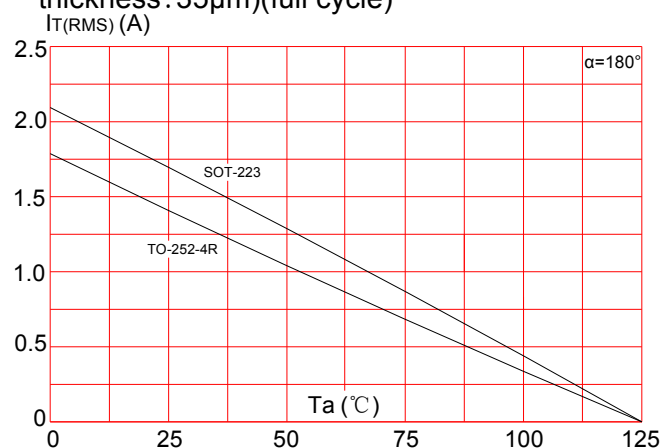

FIG.3: Surge peak on-state current versus number of cycles

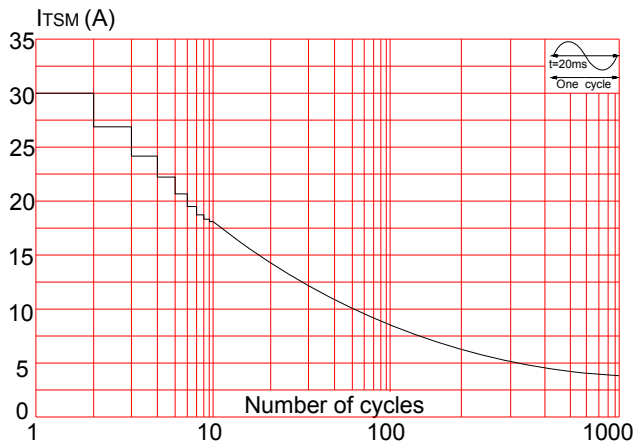

FIG.5: Relative variations of gate trigger current versus junction temperature

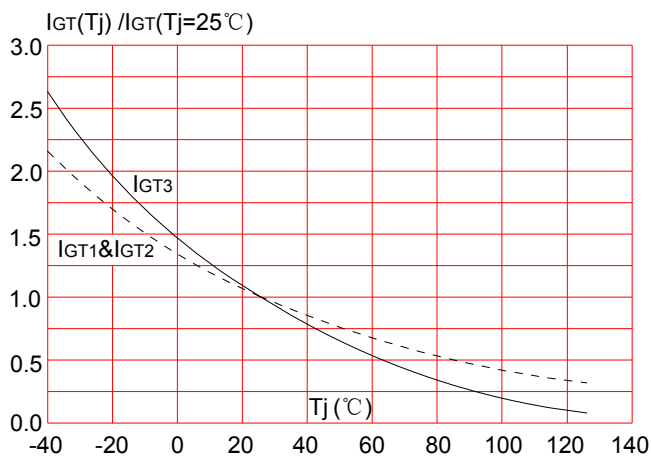

FIG.4: On-state characteristics (maximum values)

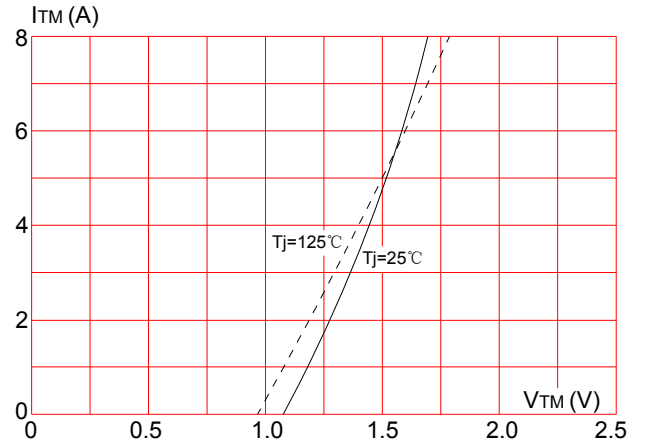
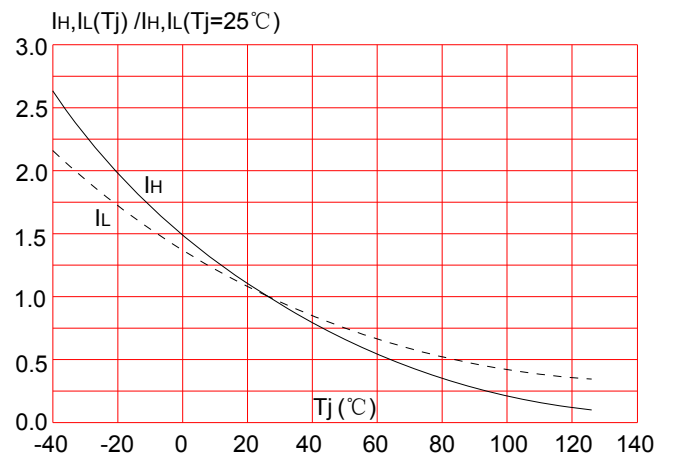
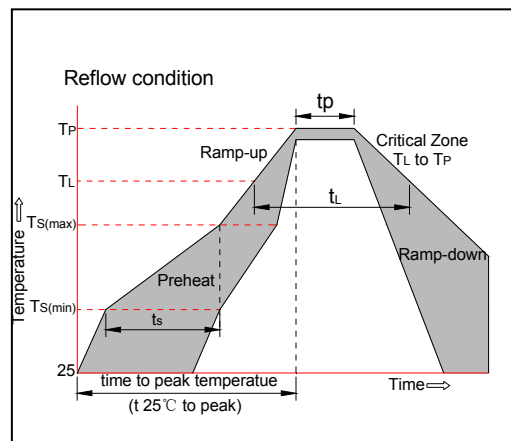

FIG.6: Relative variations of holding current, latching current versus junction temperature



SOLDERING PARAMETERS

Reflow Condition		Pb-Free assembly (see figure at right)
Pre Heat	-Temperature Min ($T_{s(min)}$)	+150°C
	-Temperature Max($T_{s(max)}$)	+200°C
	-Time (Min to Max) (t_s)	60-180 secs.
Average ramp up rate (Liquidus Temp (T_L) to peak)		3°C/sec. Max
$T_{s(max)}$ to T_L - Ramp-up Rate		3°C/sec. Max
Reflow	-Temperature(T_L)(Liquidus)	+217°C
	-Temperature(t_L)	60-150 secs.
Peak Temp (T_p)		+260(+0/-5)°C
Time within 5°C of actual Peak Temp (t_p)		20-40secs.
Ramp-down Rate		6°C/sec. Max
Time 25°C to Peak Temp (T_p)		8 min. Max
Do not exceed		+260°C



Information furnished in this document is believed to be accurate and reliable. However, Jiangsu JieJie Microelectronics Co.,Ltd assumes no responsibility for the consequences of use without consideration for such information nor use beyond it.

Information mentioned in this document is subject to change without notice, apart from that when an agreement is signed, Jiangsu JieJie complies with the agreement.

Products and information provided in this document have no infringement of patents. Jiangsu JieJie assumes no responsibility for any infringement of other rights of third parties which may result from the use of such products and information.

This document is the eleventh version which is made in 21-Apr.-2019. This document supersedes and replaces all information previously supplied.

 is a registered trademark of Jiangsu JieJie Microelectronics Co.,Ltd.

Copyright ©2019 Jiangsu JieJie Microelectronics Co.,Ltd. Printed All rights reserved.