



FEATURES

- ✧ Ultra low capacitance: 0.30pF(typical) for each channel
- ✧ Up to four I/O lines of protection
- ✧ Low operating voltage: 3.3V
- ✧ Low leakage current: 0.1 μ A@V_{RWM} (typical)
- ✧ Low clamping voltage
- ✧ Protects four data lines
- ✧ Low operating and clamping voltage
- ✧ RoHS compliant
- ✧ Meets MSL level 3

MAIN APPLICATIONS

- ✧ Serial ATA
- ✧ PCI express
- ✧ Desktops, servers and notebooks
- ✧ MDDI ports
- ✧ USB2.0, 3.0 and 3.1
- ✧ Display ports
- ✧ HDMI 1.3, 1.4 and 2.0
- ✧ Digital visual interfaces (DVI)

PROTECTION SOLUTION TO MEET

- ✧ IEC61000-4-2 (ESD) \pm 15kV (air), \pm 8kV (contact)
- ✧ IEC61000-4-4 (EFT) 40A (5/50ns)
- ✧ IEC61000-4-5 (Lightning) 6A (8/20 μ s)

MECHANICAL CHARACTERISTICS

- ✧ DFN2510-10L package
- ✧ Molding compound flammability rating: UL 94V-0
- ✧ Quantity per reel: 3,000pcs
- ✧ Lead finish: lead free
- ✧ Marking code: XaYWA

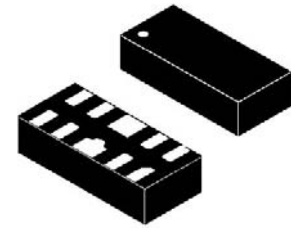

DFN2510-10L

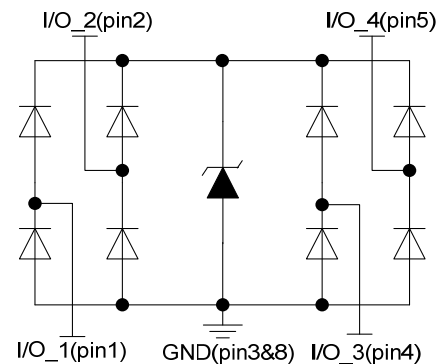

Pin configuration

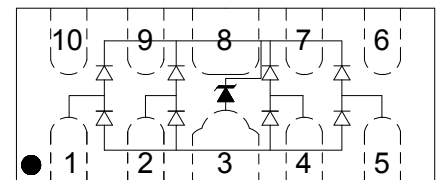

Top view

ABSOLUTE MAXIMUM RATINGS (T_A=25°C, RH=45%-75%, unless otherwise noted)

Parameter	Symbol	Value	Unit
Peak pulse power dissipation on 8/20μs waveform	P _{PP}	40	W
ESD per IEC 61000-4-2 (Air) ESD per IEC 61000-4-2 (Contact)	V _{ESD}	+/- 15 +/- 8	kV
Lead soldering temperature	T _L	260(10 sec.)	°C
Operating junction temperature range	T _J	-55 to +125	°C
Storage temperature range	T _{STG}	-55 to +150	°C

ELECTRICAL CHARACTERISTICS (T_A=25°C)

Parameter	Symbol	Conditions	Min	Typ	Max	Unit
Reverse working voltage	V _{RWM}	I/O to GND			3.3	V
Reverse leakage current	I _R	I/O to GND @V _{RWM} =3.3V		0.1	5	μA
Reverse triggering voltage	V _{t1}	I/O to GND @I _{t1} =1mA	3.7			V
Reverse holding voltage	V _h	I/O to GND @I _h =100mA	0.8	2		V
Clamping voltage	V _C ^①	I _{PP} =4A, t _P =100ns		3.0		V
		I _{PP} =16A, t _P =100ns		6.5		
Clamping voltage	V _C ^②	I _{PP} =1A, t _P =8/20μs		2	3.5	V
		I _{PP} =6A, t _P =8/20μs		5	7	
Dynamic resistance	R _{DYN} ^①	t _P =100ns		0.35		Ω
Junction capacitance	C _J	I/O to GND V _{RWM} =3.3V, f=1MHz		0.30	0.6	pF
Junction capacitance		I/O to I/O V _{RWM} =3.3V, f=1MHz		0.15	0.3	

① TLP parameter: Z₀=50Ω, t_P=100ns, t_r=2ns, averaging window from 60ns to 80ns. R_{DYN} is calculated from 4A to 16A.

② Non-repetitive current pulse, according to IEC61000-4-5.

RATINGS AND V-I CHARACTERISTICS CURVES ($T_A=25^\circ\text{C}$, unless otherwise noted)

FIG.1: V- I curve characteristics (Uni-directional)

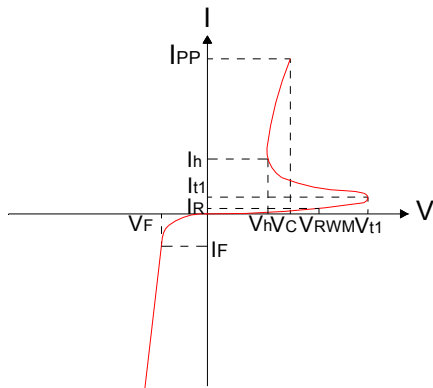

FIG.2: Pulse waveform (8/20 μs)

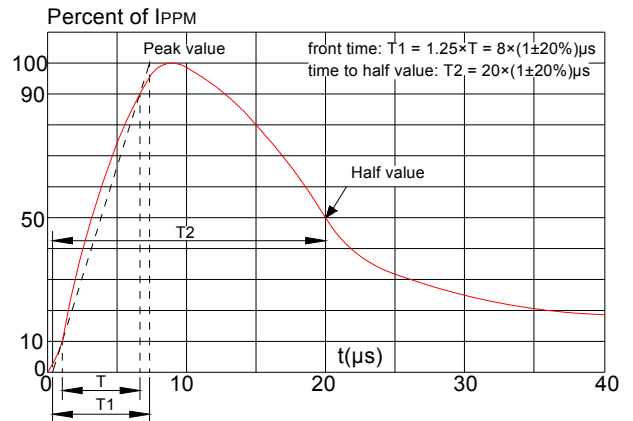

FIG.3: Pulse derating curve

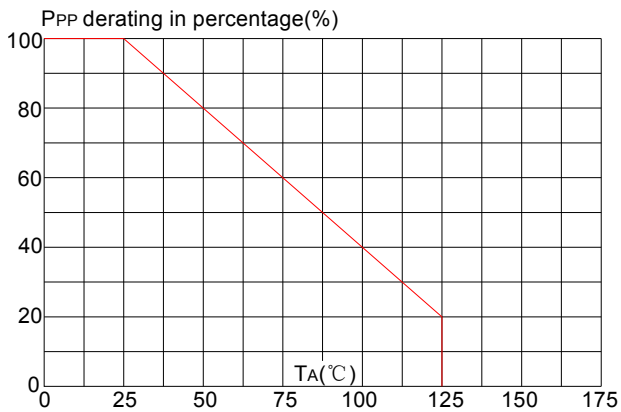

FIG.4: ESD clamping (15kV contact)

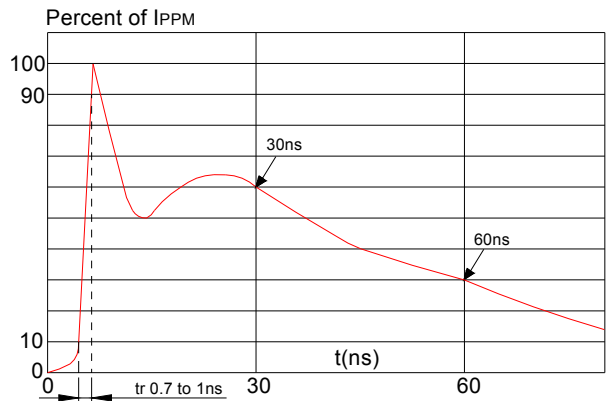

FIG.5: TLP testing of I/O to GND

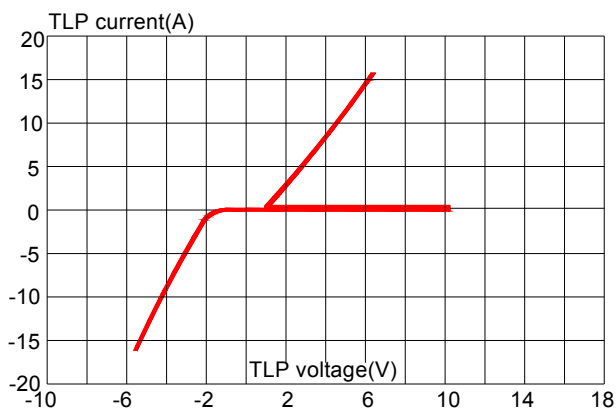
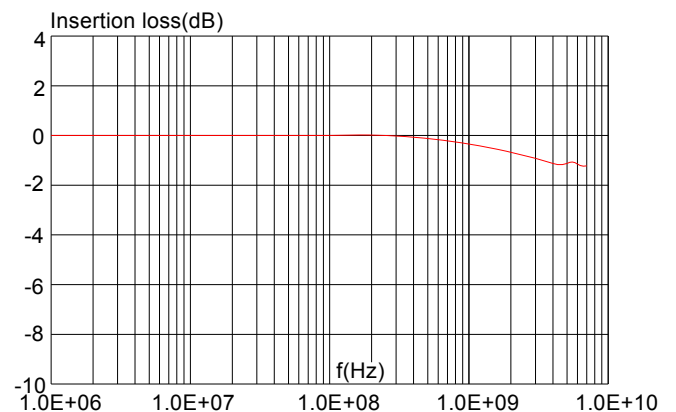
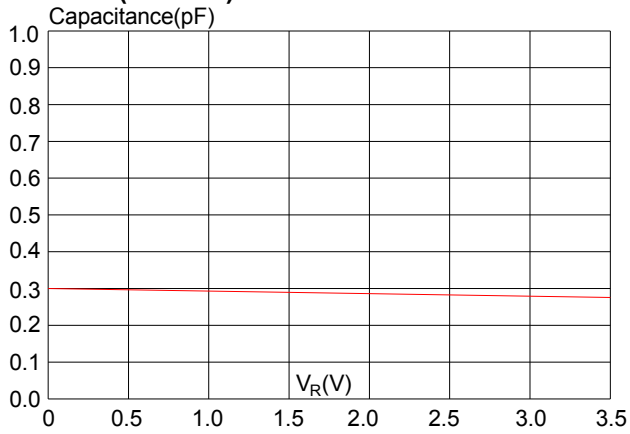

FIG.6: Insertion loss S21 of I/O to GND



**FIG.7:Capapciance vs.voltage of I/O to GND
(f=1MHz)**



**FIG.9:ESD clamping of I/O to GND
(+8kV contact per IEC 61000-4-2)**

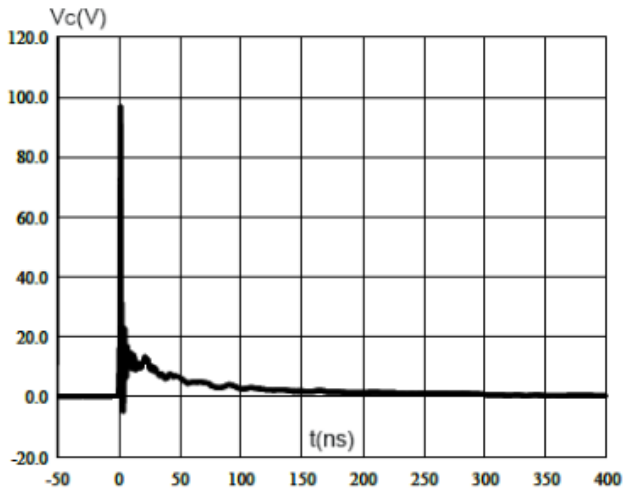
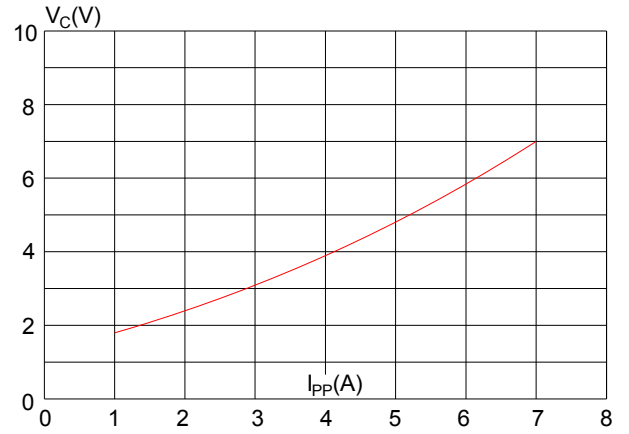
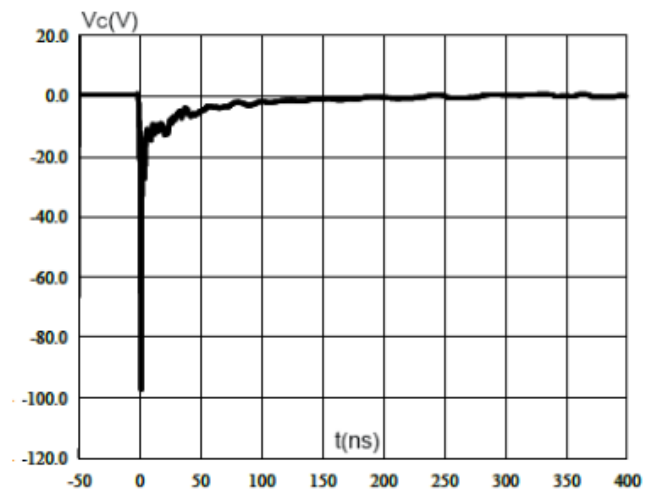

FIG.8: Clamping voltage vs. peak pulse current(8/20μs)

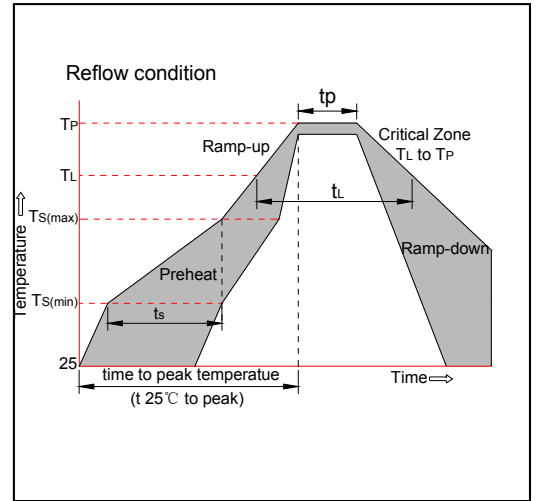

**FIG.10:ESD clamping of I/O to GND
(-8kV contact per IEC 61000-4-2)**



SOLDERING PARAMETERS

Reflow Condition		Pb-Free assembly (see figure at right)
Pre Heat	-Temperature Min ($T_{s(min)}$)	+150°C
	-Temperature Max($T_{s(max)}$)	+200°C
	-Time (Min to Max) (t_s)	60-180 secs.
Average ramp up rate (Liquidus Temp (T_L)to peak)		3°C/sec. Max
$T_{s(max)}$ to T_L - Ramp-up Rate		3°C/sec. Max
Reflow	-Temperature(T_L)(Liquidus)	+217°C
	-Temperature(t_L)	60-150 secs.
Peak Temp (T_P)		+260(+0/-5)°C
Time within 5°C of actual Peak Temp (t_p)		20-40secs.
Ramp-down Rate		6°C/sec. Max
Time 25°C to Peak Temp (T_P)		8 min. Max
Do not exceed		+260°C



PACKAGE MECHANICAL DATA

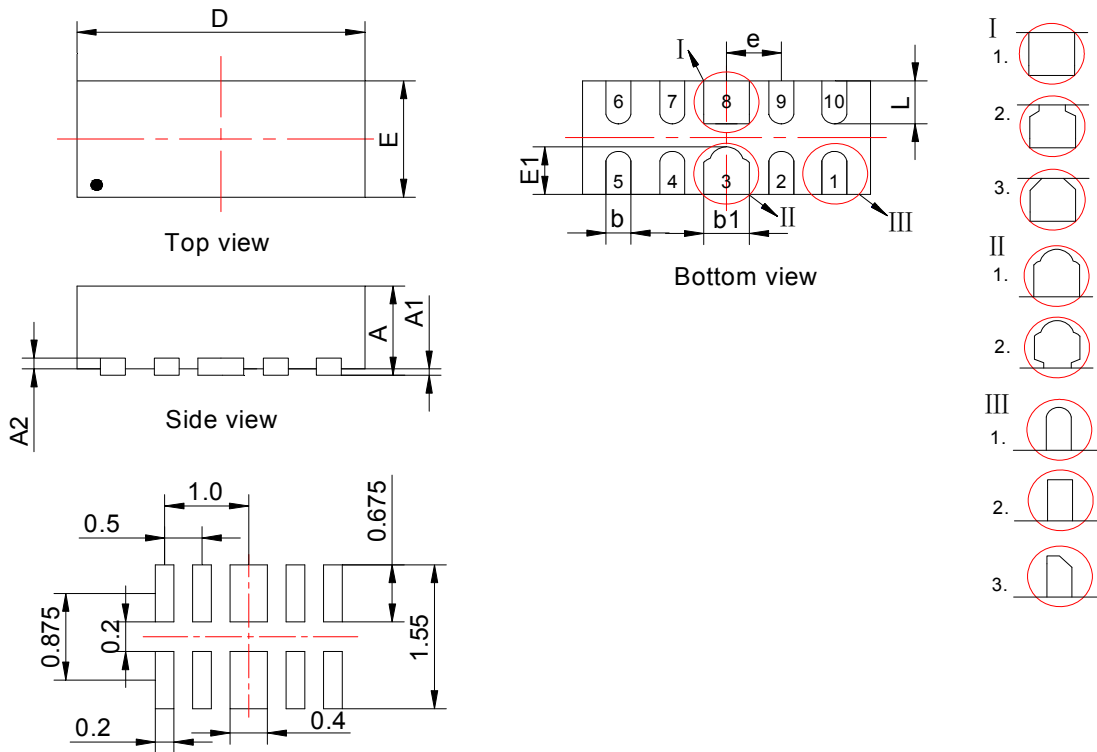

Recommended soldering footprint

Symbol	Millimeters			Inches		
	Min.	Typ.	Max.	Min.	Typ.	Max.
A	0.46	0.53	0.60	0.018	0.021	0.024
A1	0.00	0.02	0.05	0.000	0.001	0.002
A2	0.15Ref.			0.006Ref.		
b	0.15	0.20	0.25	0.006	0.008	0.010
b1	0.35	0.40	0.45	0.014	0.016	0.018
D	2.40	2.50	2.60	0.094	0.098	0.102
E	0.90	1.00	1.10	0.035	0.039	0.043
E1	0.30	0.40	0.56	0.012	0.016	0.022
e	0.50BSC			0.020BSC		
L	0.30	0.40	0.45	0.012	0.016	0.018

TAPE AND REEL INFORMATION-DFN2510-10L

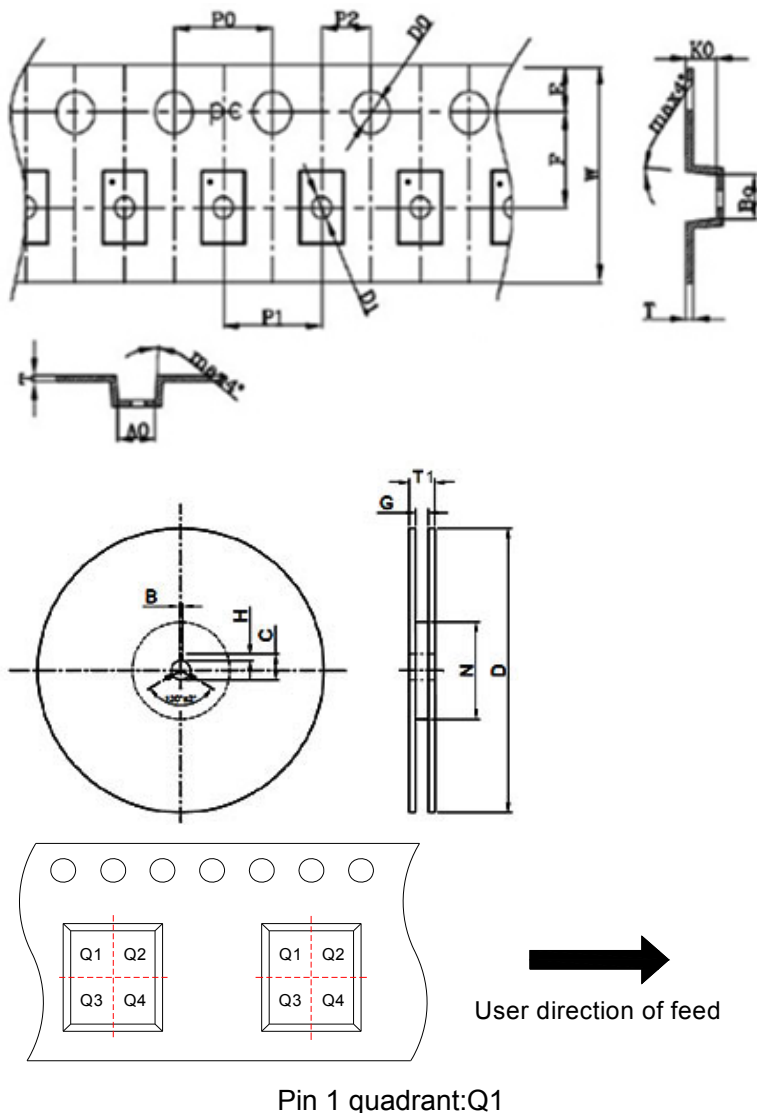

Symbol	Dimensions	
	Millimeters	Inches
	Typ.	Typ.
A0	1.20	0.047
B0	2.75	0.108
K0	0.70	0.028
P0	4.00	0.157
P1	4.00	0.157
P2	2.00	0.079
T	0.20	0.008
E	1.75	0.069
F	3.50	0.138
D0	1.55	0.061
D1	0.60	0.024
W	8.0	0.315
B	2.0	0.079
H	4.0	0.157
C	13.0	0.512
G	8.4	0.331
T1	14.9(max)	0.587(max)
N	60.0	2.362
D	178.0	7.000

ORDERING INFORMATION

PART No.	PACKAGE TYPE	QUANTITY(PCS) REEL	DESCRIPTION
JEU03SC	DFN2510-10L	3,000	7 inch reel pack

MARKING CODE

Part Number	Marking Code
JEU03SC	<div style="text-align: center; border: 1px solid black; padding: 10px; width: fit-content; margin: 0 auto;">  </div> <p>Note:</p> <p>(1) "Xa" is the part number of JEU03SC, fixed.</p> <p>(2) "YWA" is data code</p>

Information furnished in this document is believed to be accurate and reliable. However, Jiangsu JieJie Microelectronics Co.,Ltd assumes no responsibility for the consequences of use without consideration for such information nor use beyond it.

Information mentioned in this document is subject to change without notice, apart from that when an agreement is signed, Jiangsu JieJie complies with the agreement.

Products and information provided in this document have no infringement of patents. Jiangsu JieJie assumes no responsibility for any infringement of other rights of third parties which may result from the use of such products and information.

This document is the 2.3rd version which is made in 18-Aug-2020. This document supersedes and replaces all information previously supplied.

 is a registered trademark of Jiangsu JieJie Microelectronics Co.,Ltd.

Copyright ©2020 Jiangsu JieJie Microelectronics Co.,Ltd. Printed All rights reserved.