



FEATURES

- ◇ 3900 Watts peak pulse power ($t_P=8/20\mu s$)
- ◇ Working Voltage: 3.3V
- ◇ Excellent Clamping Capability
- ◇ Low Inductance

MAIN APPLICATIONS

- ◇ Power lines
- ◇ I/O Interfaces
- ◇ Automotive and Telecommunication
- ◇ Computer & Consumer Electronics
- ◇ CIndustrial Electronics
- ◇ Microcontroller Input Protection

PROTECTION SOLUTION TO MEET

- ◇ IEC61000-4-2 (ESD) $\pm 30kV$ (air), $\pm 30kV$ (contact)
- ◇ IEC61000-4-4 (EFT) 40A (5/50ns)
- ◇ IEC61000-4-5 (Lightning) 260A (8/20 μs)

MECHANICAL CHARACTERISTICS

- ◇ DFN2x2-3L package
- ◇ Molding compound flammability rating: UL 94V-0
- ◇ Quantity per reel: 3,000pcs
- ◇ Lead finish: lead free
- ◇ Marking code: M4.5A+date code

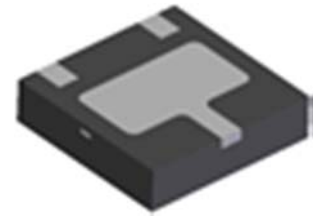

DFN2x2-3L



Circuit Diagram

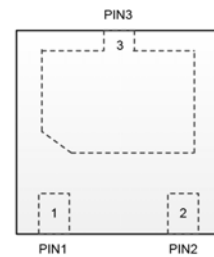

PIN Configuration

ABSOLUTE MAXIMUM RATINGS ($T_A=25^{\circ}\text{C}$, $\text{RH}=45\%-75\%$, unless otherwise noted)

Parameter	Symbol	Value	Unit
Peak pulse power($t_p=8/20\mu\text{s}$)	P_{PP}	3900	W
Peak pulse current($t_p=8/20\mu\text{s}$)	I_{PP}	260	A
Operating junction temperature range	T_J	-55 to +125	$^{\circ}\text{C}$
Storage temperature range	T_{STG}	-55 to +150	$^{\circ}\text{C}$

ELECTRICAL CHARACTERISTICS ($T_A=25^{\circ}\text{C}$)

Parameter	Symbol	Conditions	Min	Typ	Max	Unit
Reverse working voltage	V_{RWM}				3.3	V
Reverse breakdown voltage	V_{BR}	$I_T=1\text{mA}$	3.7			V
Reverse leakage current	I_R	$V_{RWM}=3.3\text{V}$			500	nA
Forward Voltage	V_F	$I_F=10\text{mA}$	0.5		1	V
Clamping voltage	V_C	$I_{PP}=260\text{A}$, $t_p=8/20\mu\text{s}$			15	V
Junction capacitance	C_J	$V_{RWM}=0\text{V}$, $f=1\text{MHz}$		850	1000	pF

RATINGS AND V-I CHARACTERISTICS CURVES ($T_A=25^{\circ}\text{C}$, unless otherwise noted)

FIG.1: V- I curve characteristics (Uni-directional)

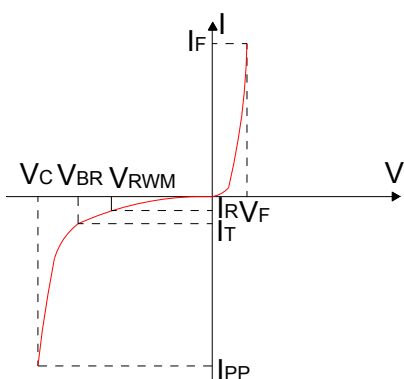

FIG.2: Pulse waveform (8/20μs)

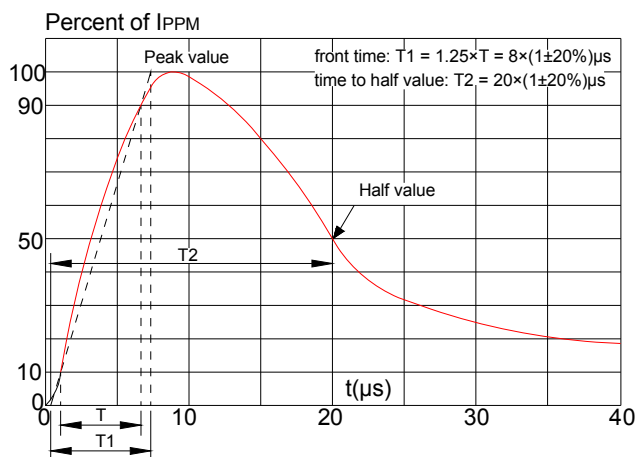

FIG.3: Pulse derating curve

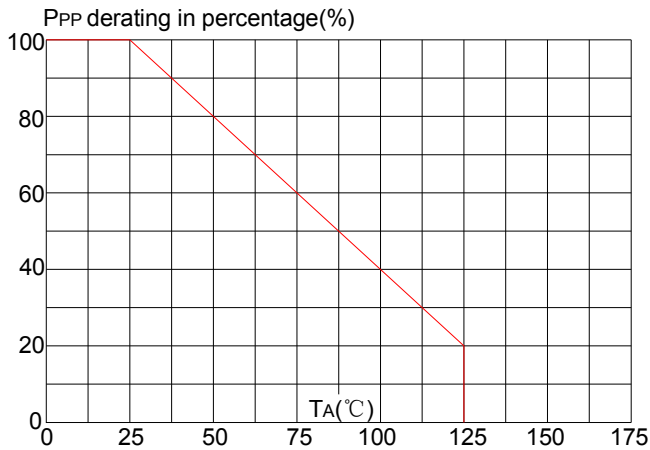

FIG.4: ESD clamping (30KV contact)

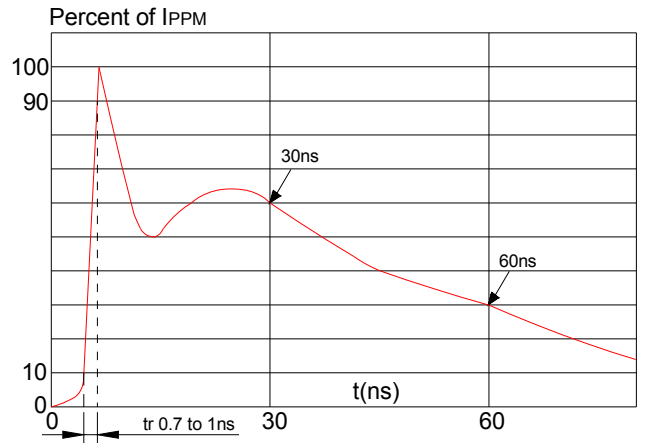

FIG.5:Clamping voltage vs.peak pulse current

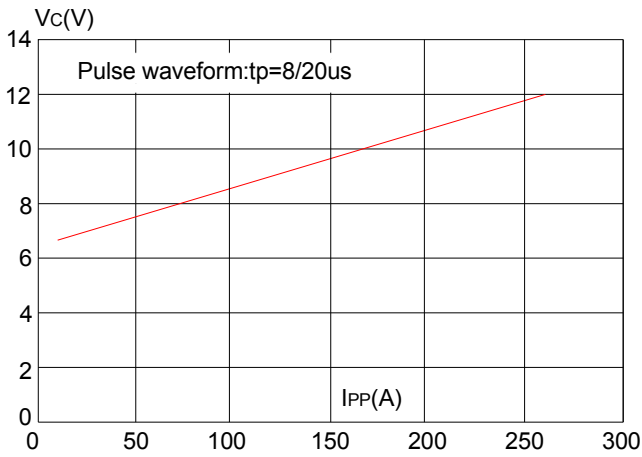
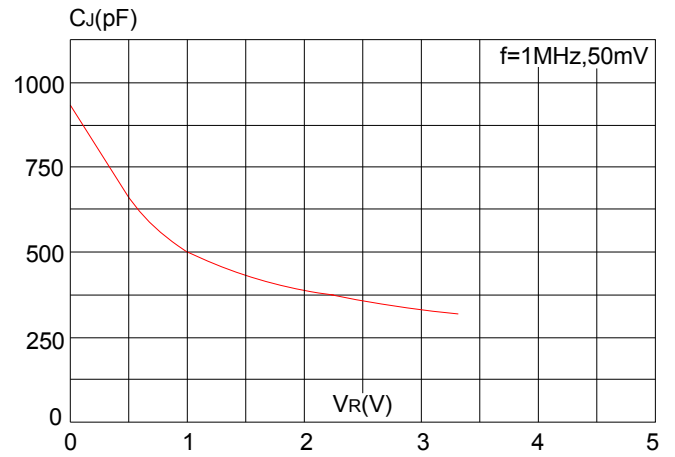
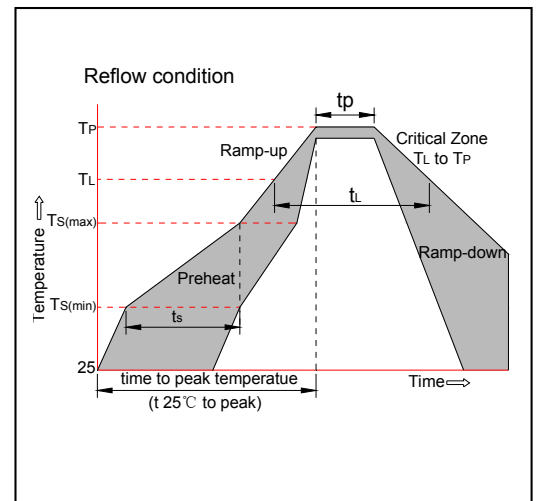

FIG.6:Capacitance vs.reverse voltage



SOLDERING PARAMETERS

Reflow Condition		Pb-Free assembly (see figure at right)
Pre Heat	-Temperature Min (Ts(min))	+150°C
	-Temperature Max(Ts(max))	+200°C
	-Time (Min to Max) (ts)	60-180 secs.
Average ramp up rate (Liquidus Temp (TL)to peak)		3°C/sec. Max
Ts(max) to TL - Ramp-up Rate		3°C/sec. Max
Reflow	-Temperature(TL)(Liquidus)	+217°C
	-Temperature(tL)	60-150 secs.
Peak Temp (Tp)		+260(+0/-5)°C
Time within 5°C of actual Peak Temp (tp)		20-40secs.
Ramp-down Rate		6°C/sec. Max
Time 25°C to Peak Temp (Tp)		8 min. Max
Do not exceed		+260°C



PACKAGE MECHANICAL DATA

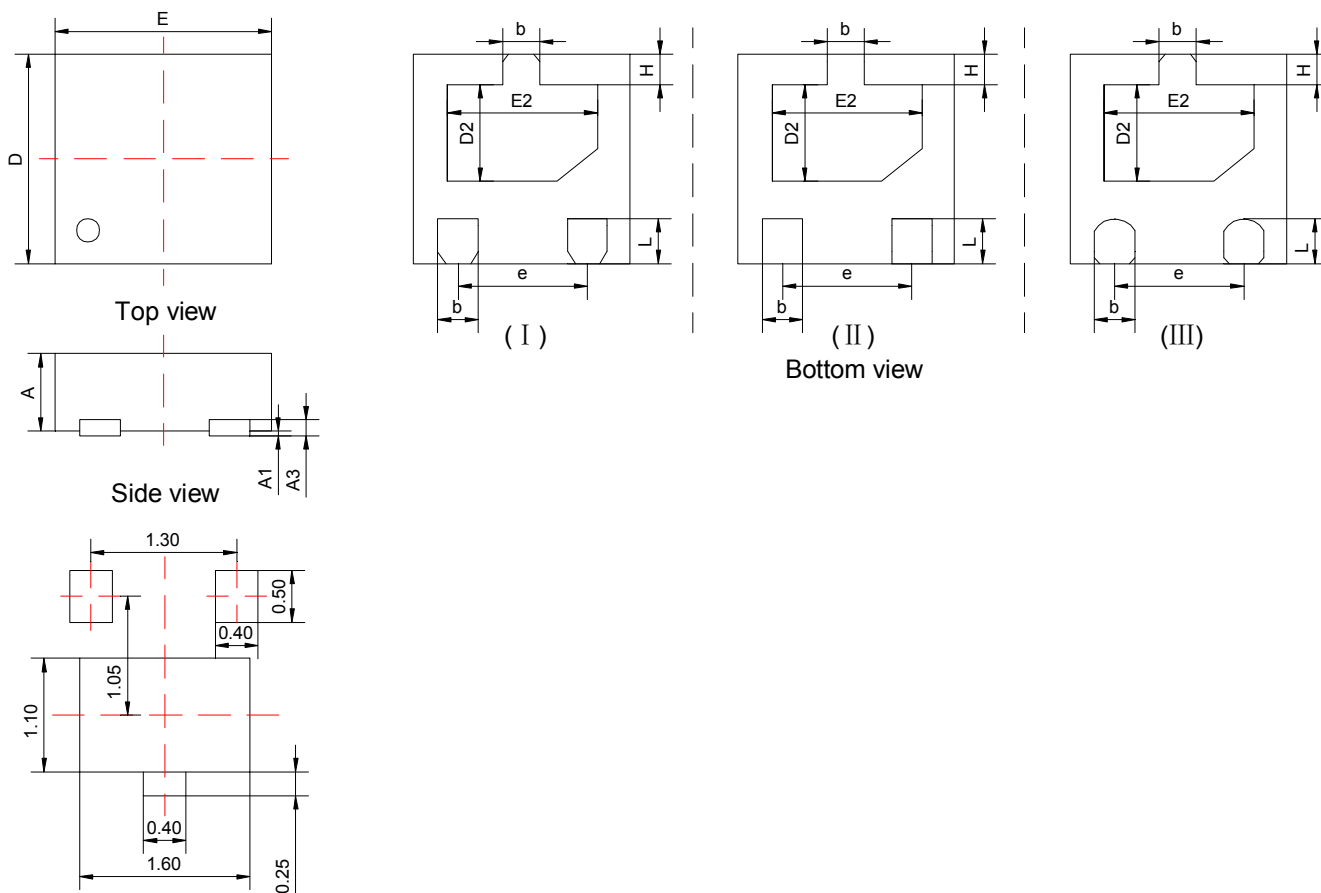

Recommended soldering footprint(mm)

Symbol	Millimeters			Inches		
	Min.	Typ.	Max.	Min.	Typ.	Max.
A	0.45	0.50	0.60	0.018	0.020	0.024
A1	0.00	0.02	0.05	0.000	0.001	0.002
A3	0.15REF			0.006REF		
b	0.25	0.30	0.35	0.010	0.012	0.014
D	1.90	2.00	2.10	0.075	0.079	0.083
E	1.90	2.00	2.10	0.075	0.079	0.083
D2	0.85	1.05	1.15	0.033	0.041	0.045
E2	1.40	1.50	1.60	0.055	0.059	0.063
e	1.30BSC			0.051BSC		
H	0.20	0.25	0.30	0.008	0.010	0.012
L	0.35	0.40	0.45	0.014	0.016	0.018

TAPE AND REEL INFORMATION-DFN2x2-3L

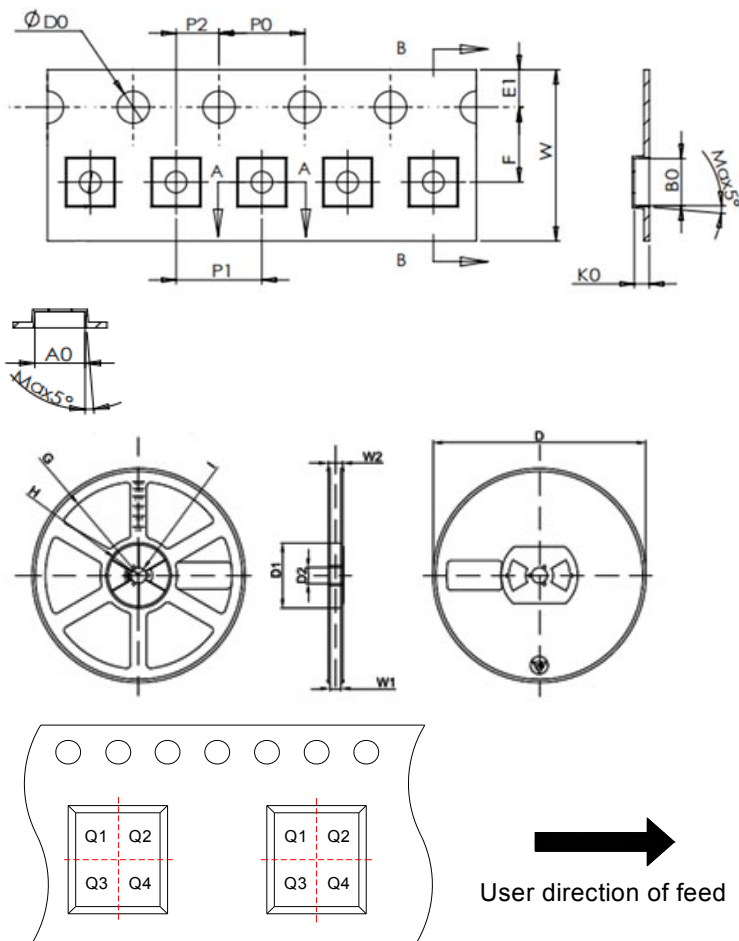

Pin 1 quadrant: Q3

Packaging Description:

DFN2x2-3L parts are shipped in tape. The carrier tape is made from a dissipative(carbon filled) polycarbonate resin. The cover tape is a multilayer film(heat activated adhesive in nature)primarily composed of polyester film, adhesive layer, sealant, and anti-static sprayed agent. These reeled parts in standard option are shipped with 3,000units per 7" or 17.8cm diameter reel. The reels are clear in color and made of polystyrene plastic(anti-static coated).

Symbol	Dimensions	
	Millimeters	Inches
	Typ.	Typ.
A0	2.20	0.087
B0	2.20	0.087
K0	0.70	0.028
D0	1.55	0.061
E1	1.75	0.069
F	3.50	0.138
P0	4.00	0.157
P1	4.00	0.157
P2	2.00	0.079
W	8.00	0.315
D	Φ178	Φ7.008
D1	54.40	2.142
D2	13.00	0.512
G	R78.00	R3.071
H	R25.60	R1.008
I	R6.50	R0.256
W1	9.50	0.374
W2	12.30	0.484

ORDERING INFORMATION

PART No.	PACKAGE TYPE	QUANTITY(PCS) REEL	DESCRIPTION
JEU3V3N3	DFN2x2-3L	3,000	7 Inch

MARKING CODE

Part Number	Marking Code
JEU3V3N3	<div style="display: flex; align-items: center;"> <div style="border: 1px solid black; padding: 5px; margin-right: 10px;"> <p>M4.5A XXXX ●</p> </div> <div> <p>M4.5A=Special Device Code XXXX=Date Code</p> </div> </div>

Information furnished in this document is believed to be accurate and reliable. However, Jiangsu JieJie Microelectronics Co.,Ltd assumes no responsibility for the consequences of use without consideration for such information nor use beyond it.

Information mentioned in this document is subject to change without notice, apart from that when an agreement is signed, Jiangsu JieJie complies with the agreement.

Products and information provided in this document have no infringement of patents. Jiangsu JieJie assumes no responsibility for any infringement of other rights of third parties which may result from the use of such products and information.

This document is the 1.2nd version which is made in 22-Oct.-2021. This document supersedes and replaces all information previously supplied.

 is a registered trademark of Jiangsu JieJie Microelectronics Co.,Ltd.

Copyright ©2021 Jiangsu JieJie Microelectronics Co.,Ltd. Printed All rights reserved.