



SMFxxAL Series 400W Transient Voltage Suppressor

Rev.3.5

DESCRIPTION:

TVS diodes can be used in a wide range of applications which like consumer electronic products, automotive industries, munitions, telecommunications, aerospace industries, and intelligent control systems.

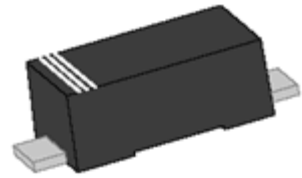

SOD-123FL

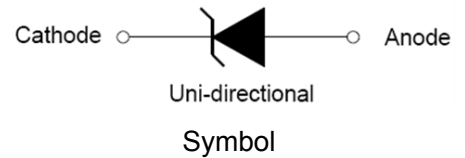

FEATURES:

- ✧ Low profile package.
- ✧ Low inductance.
- ✧ Excellent clamping capability.
- ✧ 400W peak pulse power capability at 10/1000µs waveform.
- ✧ Typical I_R less than 1µA above 10V.
- ✧ Fast response time: typically less than 1.0ps from 0V to V_{BR} min.
- ✧ High temperature reflow soldering: 260°C/40s at terminals.
- ✧ Plastic package has underwriters laboratory flammability 94V-0.
- ✧ Meets MSL level 1, per J-STD-020, LF maximum peak of 260°C.
- ✧ Terminal: solder plated, solderable per J-STD-002.
- ✧ For surface mounted applications in order to optimize board space.
- ✧ IEC61000-4-2 (ESD) ±30kV (air), ±30kV (contact).

ABSOLUTE MAXIMUM RATINGS ($T_A=25^\circ\text{C}$, RH=45%-75%, unless otherwise noted)

Parameter	Symbol	Value	Unit
Storage and operating junction temperature range	T_{STG}/ T_J	-55 to +150	°C
Peak pulse power dissipation at 10/1000µs waveform	P_{PP}	400	W
Maximum instantaneous forward voltage at 20A for unidirectional	V_F	5.0	V
Typical thermal resistance junction to lead	$R_{\theta JL}$	100	°C/W
Typical thermal resistance junction to ambient	$R_{\theta JA}$	220	°C/W

MARKING



AE : Device Marking Code

ELECTRICAL CHARACTERISTICS (T_A=25°C)

Part Number	Marking	V _R	I _{R@V_R}	V _{BR@I_T}		I _T	V _{C@I_{PP}}	I _{PP} ^①
				min(V)	max(V)			
Uni-Polar	Uni	V	max(μA)	min(V)	max(V)	mA	max(V)	A
SMF5.0AL	AE	5.0	40	6.40	7.00	10	9.2	43.5
SMF6.0AL	AG	6.0	40	6.67	7.37	10	10.3	38.8
SMF6.5AL	AK	6.5	30	7.22	7.98	10	11.2	35.7
SMF7.0AL	AM	7.0	30	7.78	8.60	10	12.0	33.3
SMF7.5AL	AP	7.5	30	8.33	9.21	1	12.9	31.0
SMF8.0AL	AR	8.0	20	8.89	9.83	1	13.6	29.4
SMF8.5AL	AT	8.5	10	9.44	10.40	1	14.4	27.8
SMF9.0AL	AV	9.0	5	10.00	11.10	1	15.4	26.0
SMF10AL	AX	10.0	2	11.10	12.30	1	17.0	23.5
SMF11AL	AZ	11.0	1	12.20	13.50	1	18.2	22.0
SMF12AL	BE	12.0	1	13.30	14.70	1	19.9	20.1
SMF13AL	BG	13.0	1	14.40	15.90	1	21.5	18.6
SMF14AL	BK	14.0	1	15.60	17.20	1	23.2	17.2
SMF15AL	BM	15.0	1	16.70	18.50	1	24.4	16.4
SMF17AL	BR	17.0	1	18.90	20.90	1	27.6	14.5
SMF18AL	BT	18.0	1	20.00	22.10	1	29.2	13.7
SMF20AL	BV	20.0	1	22.20	24.50	1	32.4	12.3
SMF22AL	BX	22.0	1	24.40	26.90	1	35.5	11.3
SMF24AL	BZ	24.0	1	26.70	29.50	1	38.9	10.3
SMF26AL	CE	26.0	1	28.90	31.90	1	42.1	9.5
SMF28AL	CG	28.0	1	31.10	34.40	1	45.4	8.8
SMF30AL	CK	30.0	1	33.30	36.80	1	48.4	8.3
SMF33AL	CM	33.0	1	36.70	40.60	1	53.3	7.5
SMF36AL	CP	36.0	1	40.00	44.20	1	58.1	6.9

ELECTRICAL CHARACTERISTICS (T_A=25°C, continued)

Part Number	Marking	V _R	I _R @V _R	V _{BR} @I _T		I _T	V _C @I _{PP}	I _{PP} ^①
				min(V)	max(V)			
Uni-Polar	Uni	V	max(μA)			mA	max(V)	A
SMF40AL	CR	40.0	1	44.40	49.10	1	64.5	6.2
SMF43AL	CT	43.0	1	47.80	52.80	1	69.4	5.8
SMF45AL	CV	45.0	1	50.00	55.30	1	72.7	5.5
SMF48AL	CX	48.0	1	53.30	58.90	1	77.4	5.2
SMF51AL	CZ	51.0	1	56.70	62.70	1	82.4	4.9
SMF58AL	DE	58.0	1	64.40	71.20	1	93.6	4.3
SMF60AL	DG	60.0	1	66.70	73.70	1	96.8	4.1
SMF64AL	DM	64.0	1	71.10	78.60	1	103.0	3.9
SMF70AL	DP	70.0	1	77.80	86.00	1	113.0	3.5
SMF75AL	DR	75.0	1	83.30	92.10	1	121.0	3.3
SMF78AL	DT	78.0	1	86.70	95.80	1	126.0	3.2
SMF85AL	DV	85.0	1	94.40	104.00	1	137.0	2.9

① Surge waveform: 10/1000μs

V_R: Stand-off voltage -- maximum voltage that can be applied

V_{BR}: Breakdown voltage

V_C: Clamping voltage -- peak voltage measured across the suppressor at a specified I_{PP}

I_R: Reverse leakage current

ORDERING INFORMATION

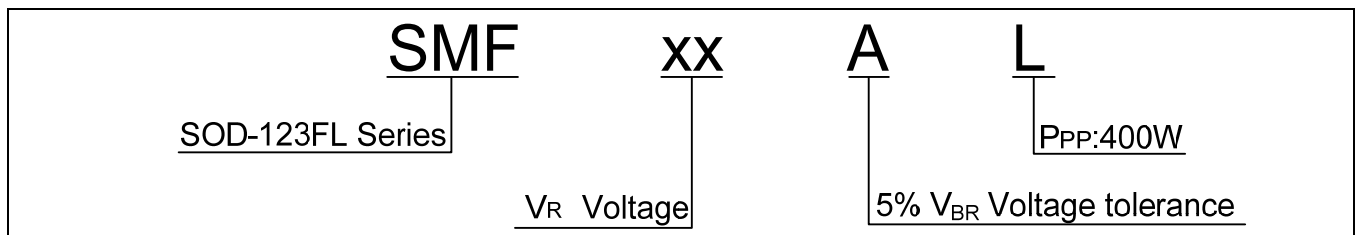

RATINGS AND V-I CHARACTERISTICS CURVES ($T_A=25^{\circ}\text{C}$, unless otherwise noted)

FIG.1: V- I curve characteristics (Uni-directional)

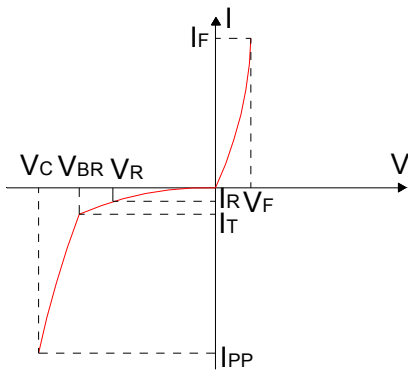

FIG.2: Pulse waveform

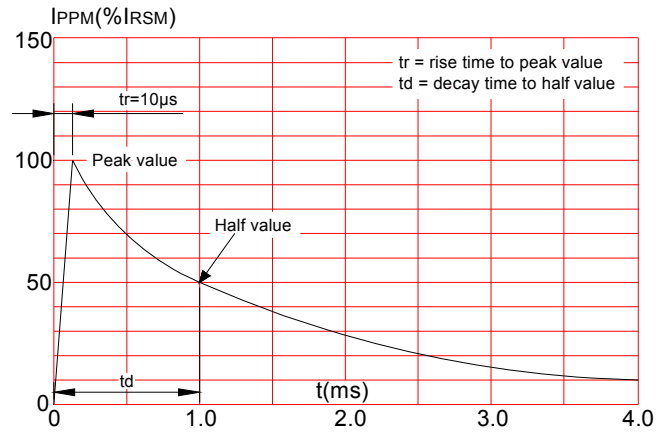
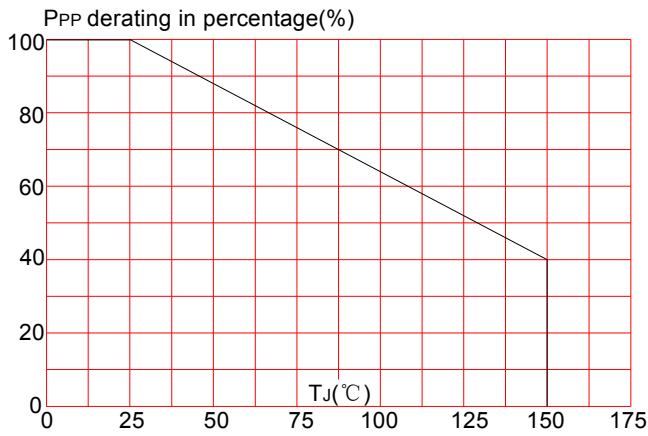
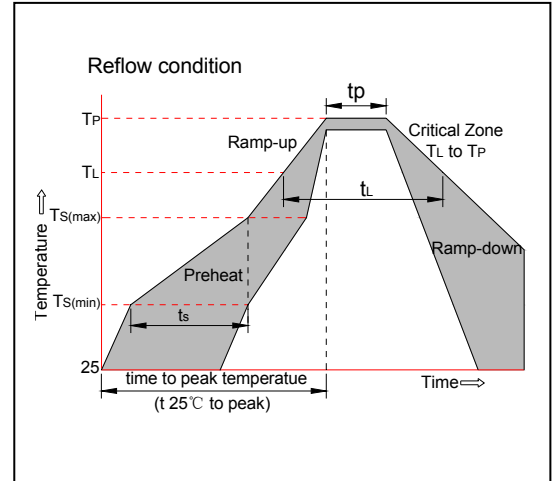

FIG.3: Pulse derating curve



SOLDERING PARAMETERS

Reflow Condition		Pb-Free assembly (see figure at right)
Pre Heat	-Temperature Min ($T_{s(min)}$)	+150°C
	-Temperature Max($T_{s(max)}$)	+200°C
	-Time (Min to Max) (ts)	60-180 secs.
Average ramp up rate (Liquidus Temp (T_L)to peak)		3°C/sec. Max
$T_{s(max)}$ to T_L - Ramp-up Rate		3°C/sec. Max
Reflow	-Temperature(T_L)(Liquidus)	+217°C
	-Temperature(t_L)	60-150 secs.
Peak Temp (T_p)		+260(+0/-5)°C
Time within 5°C of actual Peak Temp (t_p)		20-40secs.
Ramp-down Rate		6°C/sec. Max
Time 25°C to Peak Temp (T_p)		8 min. Max
Do not exceed		+260°C



PACKAGE MECHANICAL DATA

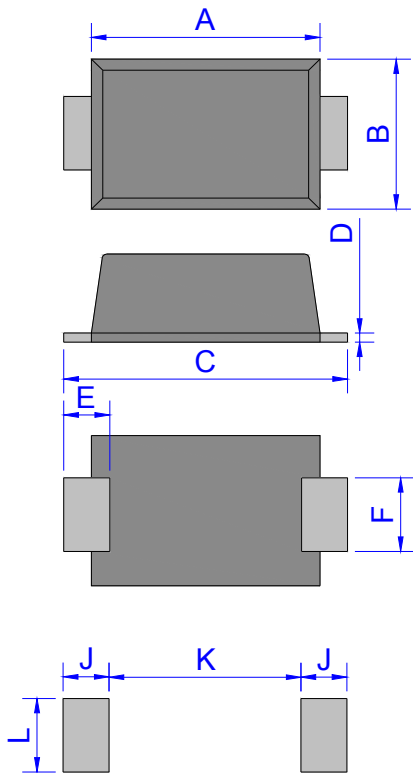

SOD-123FL

Ref.	Dimensions			
	Millimeters		Inches	
	Min.	Max.	Min.	Max.
A	2.60	3.00	0.102	0.118
B	1.60	2.00	0.063	0.079
C	3.45	3.95	0.136	0.156
D	0.10	0.25	0.004	0.01
E	0.3	0.9	0.012	0.035
F	0.80	1.20	0.031	0.047
G	0.95	1.35	0.037	0.053
J	1.30		0.051	
K		1.70		0.067
L	1.30		0.051	

TAPE AND REEL SPECIFICATION-SOD-123FL

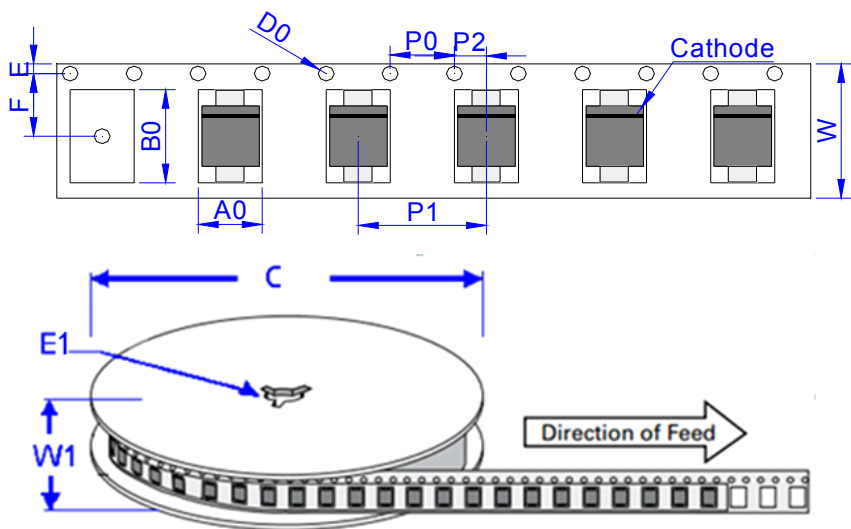

Ref.	Dimensions	
	Millimeters	Inches
A0	1.95 ± 0.3	0.077± 0.012
B0	3.95 ± 0.3	0.156 ± 0.012
C	178	7.0
D0	1.55 ± 0.1	0.061 ± 0.004
E	1.75 ± 0.2	0.069 ± 0.008
E1	13.3 ± 0.3	0.524± 0.012
F	3.50 ± 0.2	0.138 ± 0.008
P0	4.00 ± 0.2	0.157 ± 0.008
P1	4.00 ± 0.2	0.157 ± 0.008
P2	2.00 ± 0.2	0.079 ± 0.008
W	8.0± 0.2	0.315 ± 0.008
W1	11.5 ± 1.0	0.453 ± 0.039

PART No.	UNIT WEIGHT (g/PCS) typ.	REEL (PCS)	PER CARTON (PCS)	DESCRIPTION
SMFxxAL	0.0136	3000	150,000	7 inch reel pack

Information furnished in this document is believed to be accurate and reliable. However, Jiangsu JieJie Microelectronics Co.,Ltd assumes no responsibility for the consequences of use without consideration for such information nor use beyond it.

Information mentioned in this document is subject to change without notice, apart from that when an agreement is signed, Jiangsu JieJie complies with the agreement.

Products and information provided in this document have no infringement of patents. Jiangsu JieJie assumes no responsibility for any infringement of other rights of third parties which may result from the use of such products and information.

This document is the 3.5th version which is made in 2-Aug.-2021. This document supersedes and replaces all information previously supplied.

 is a registered trademark of Jiangsu JieJie Microelectronics Co.,Ltd.

Copyright©2021 Jiangsu JieJie Microelectronics Co.,Ltd. Printed All rights reserved.