



30KP Series 30000W Transient Voltage Suppressor

Rev.2.5

DESCRIPTION

The 30KP series of high current uni/bi-directional transient suppressors are designed for A.C. line protection and high power DC bus clamping applications. These devices offer uni/bi-directional port protection from 28 volts to 400 volts. They provide a clamping voltage lower than the avalanche voltage. Therefore, any voltage rise due to increased current conduction is contained to a minimum, providing the best possible protection level. They can also be connected in series and/or parallel to create very high capacity protection solutions.



R-6/P-600

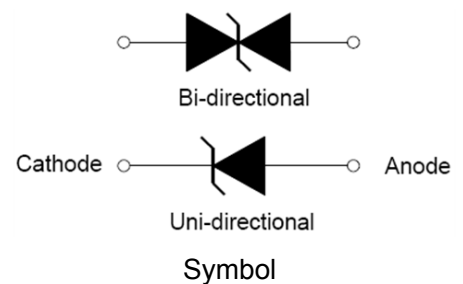

FEATURES

- ✧ Low incremental surge resistance.
- ✧ Excellent clamping capability.
- ✧ Typical I_R less than $2\mu A$ above 64V.
- ✧ Color band denoted cathode except bidirectional.
- ✧ High temperature wave soldering: $265^\circ C/10s$ at terminals.
- ✧ Plastic package has underwriters laboratory flammability 94V-0.
- ✧ 30000W peak pulse power capability at 10/1000 μs waveform.
- ✧ Meets MSL level 1, per J-STD-020, LF maximum peak of $260^\circ C$.
- ✧ Terminal: solder plated, solderable per J-STD-002.
- ✧ Fast response time: typically less than 1.0ps from 0V to V_{BR} min.
- ✧ UL 497B item recognized. (File No.:E480698).
- ✧ IEC61000-4-2 (ESD) $\pm 30kV$ (air), $\pm 30kV$ (contact).

ABSOLUTE MAXIMUM RATINGS ($T_A=25^\circ C$, RH=45%-75%, unless otherwise noted)

Parameter	Symbol	Value	Unit
Operating junction and storage temperature range	T_J, T_{STG}	-55 to +175	$^\circ C$
Peak pulse power dissipation at 10/1000 μs waveform	P_{PP}	30000	W
Steady state power dissipation at $T_L=75^\circ C$	$P_{M(AV)}$	8	W
Peak forward surge current, 8.3ms single half sine-wave for unidirectional only	I_{FSM}	400	A

ABSOLUTE MAXIMUM RATINGS($T_A=25^{\circ}\text{C}$, RH=45%-75%, unless otherwise noted, continued)

Parameter	Symbol	Value	Unit
Typical thermal resistance junction to lead	$R_{\theta JL}$	8.0	$^{\circ}\text{C}/\text{W}$
Typical thermal resistance junction to ambient	$R_{\theta JA}$	40	$^{\circ}\text{C}/\text{W}$

ELECTRICAL CHARACTERISTICS ($T_A=25^{\circ}\text{C}$)

Part Number		V_R	$I_R@V_R$	$V_{BR}@I_T$		I_T	$V_C@I_{PP}$	$I_{PP}^{\text{①}}$
Uni-Polar	Bi-Polar	V	max(μA)	min(V)	max(V)	mA	max(V)	A
30KP28A	30KP28CA	28.0	5000	31.28	34.41	50	50.0	606.0
30KP30A	30KP30CA	30.0	5000	33.51	36.86	50	55.2	548.9
30KP33A	30KP33CA	33.0	5000	36.90	40.59	50	58.5	517.9
30KP36A	30KP36CA	36.0	5000	40.20	44.22	50	61.8	490.3
30KP39A	30KP39CA	39.0	2000	43.60	47.96	20	67.2	450.9
30KP42A	30KP42CA	42.0	1000	46.90	51.59	10	72.0	420.8
30KP43A	30KP43CA	43.0	1000	48.00	52.80	10	73.0	415.1
30KP45A	30KP45CA	45.0	250	50.30	55.33	5	77.4	391.5
30KP48A	30KP48CA	48.0	150	53.60	58.96	5	81.6	371.3
30KP51A	30KP51CA	51.0	50	57.00	62.70	5	86.4	350.7
30KP54A	30KP54CA	54.0	20	60.30	66.33	5	91.4	331.5
30KP58A	30KP58CA	58.0	20	64.80	71.28	5	92.4	327.9
30KP60A	30KP60CA	60.0	15	67.00	73.70	5	102.0	297.1
30KP64A	30KP64CA	64.0	10	71.50	78.65	5	104.0	291.3
30KP66A	30KP66CA	66.0	2	73.70	81.07	5	107.0	283.2
30KP70A	30KP70CA	70.0	2	78.20	86.02	5	109.0	278.0
30KP71A	30KP71CA	71.0	2	79.30	87.23	5	111.5	271.7
30KP72A	30KP72CA	72.0	2	80.40	88.44	5	114.0	265.8
30KP75A	30KP75CA	75.0	2	83.80	92.18	5	119.4	253.8
30KP78A	30KP78CA	78.0	2	87.10	95.81	5	129.0	234.9
30KP84A	30KP84CA	84.0	2	93.80	103.18	5	139.2	217.7
30KP90A	30KP90CA	90.0	2	100.50	110.55	5	146.4	207.0
30KP96A	30KP96CA	96.0	2	107.20	117.92	5	156.0	194.2
30KP102A	30KP102CA	102.0	2	113.90	125.29	5	165.6	183.0

ELECTRICAL CHARACTERISTICS (T_A=25°C, continued)

Part Number		V _R	I _R @V _R	V _{BR} @I _T		I _T	V _C @I _{PP}	I _{PP} ^①
Uni-Polar	Bi-Polar	V	max(μA)	min(V)	max(V)	mA	max(V)	A
30KP108A	30KP108CA	108.0	2	120.60	132.66	5	175.2	172.9
30KP120A	30KP120CA	120.0	2	134.00	147.40	5	194.4	155.9
30KP132A	30KP132CA	132.0	2	147.40	162.14	5	213.0	142.3
30KP144A	30KP144CA	144.0	2	160.80	176.88	5	223.2	135.8
30KP150A	30KP150CA	150.0	2	167.60	184.36	5	233.4	129.8
30KP156A	30KP156CA	156.0	2	174.30	191.73	5	245.0	123.7
30KP160A	30KP160CA	160.0	2	178.70	196.57	5	252.6	120.0
30KP168A	30KP168CA	168.0	2	187.70	206.47	5	272.4	111.2
30KP170A	30KP170CA	170.0	2	189.90	208.89	5	275.0	110.2
30KP180A	30KP180CA	180.0	2	201.10	221.21	5	290.4	104.3
30KP198A	30KP198CA	198.0	2	221.20	243.32	5	319.8	94.7
30KP216A	30KP216CA	216.0	2	241.30	265.43	5	348.6	86.9
30KP240A	30KP240CA	240.0	2	268.10	294.91	5	387.0	78.3
30KP258A	30KP258CA	258.0	2	288.20	317.02	5	414.4	72.8
30KP260A	30KP260CA	260.0	2	290.40	319.44	5	416.0	72.5
30KP270A	30KP270CA	270.0	2	301.60	331.76	5	436.2	69.5
30KP280A	30KP280CA	280.0	2	312.80	344.08	5	464.0	65.3
30KP288A	30KP288CA	288.0	2	321.70	353.87	5	469.9	64.5
30KP300A	30KP300CA	300.0	2	334.00	367.40	5	484.0	62.0
30KP320A	30KP320CA	320.0	2	357.40	391.40	5	530.0	57.2
30KP345A	30KP345CA	345.0	2	385.40	421.90	5	560.0	53.6
30KP350A	30KP350CA	350.0	2	391.00	428.10	5	567.0	53.4
30KP360A	30KP360CA	360.0	2	402.10	440.30	5	640.0	47.3
30KP400A	30KP400CA	400.0	2	447.00	494.00	5	648.0	46.3

① Surge waveform: 10/1000μs

V_R: Stand-off voltage -- Maximum voltage that can be applied

V_{BR}: Breakdown voltage

V_C: Clamping voltage -- Peak voltage measured across the suppressor at a specified I_{PP}

I_R: Reverse leakage current

RATINGS AND V-I CHARACTERISTICS CURVES ($T_A=25^{\circ}\text{C}$, unless otherwise noted)

FIG.1:V- I curve characteristics (Uni-directional)

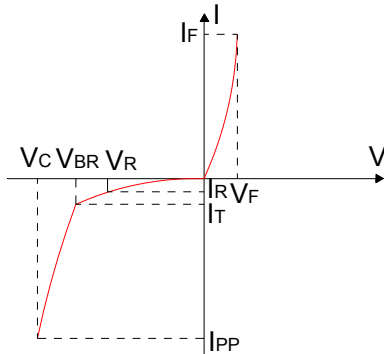

FIG.2:V- I curve characteristics (Bi-directional)

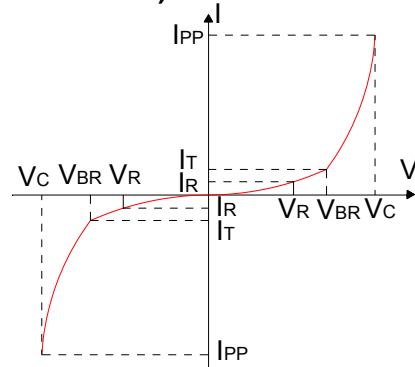

FIG.3: Pulse waveform

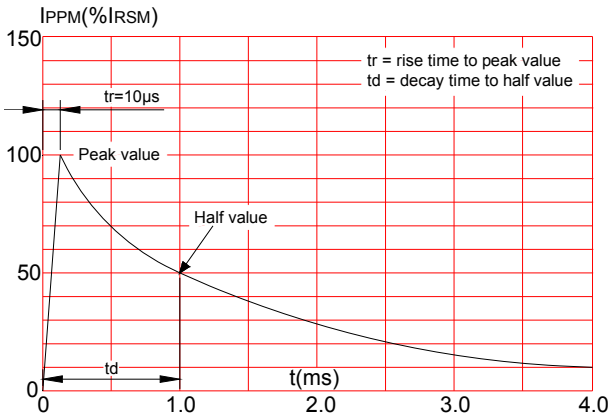
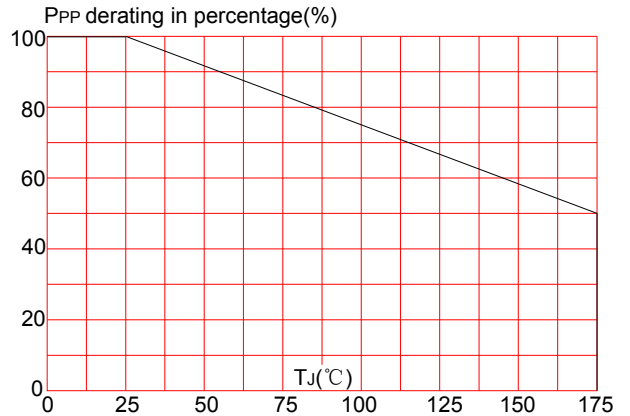
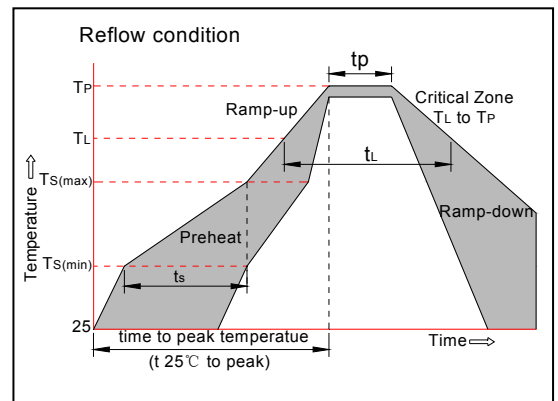

FIG.4: Pulse derating curve



SOLDERING PARAMETERS

Reflow Condition		Pb-Free assembly (see figure at right)
Pre Heat	-Temperature Min ($T_{s(min)}$)	+150°C
	-Temperature Max($T_{s(max)}$)	+200°C
	-Time (Min to Max) (t_s)	60-180 secs.
Average ramp up rate (Liquidus Temp (T_L)to peak)		3°C/sec. Max
$T_{s(max)}$ to T_L - Ramp-up Rate		3°C/sec. Max
Reflow	-Temperature(T_L)(Liquidus)	+217°C
	-Temperature(t_L)	60-150 secs.
Peak Temp (T_p)		+260(+0/-5)°C
Time within 5°C of actual Peak Temp (t_p)		20-40secs.
Ramp-down Rate		6°C/sec. Max
Time 25°C to Peak Temp (T_p)		8 min. Max
Do not exceed		+260°C



Flow/Wave Soldering(Solder Dipping)	
Peak temperature	265°C
Dipping time	10 sec.
Soldering	1 time

MARKING & ORDERING INFORMATION

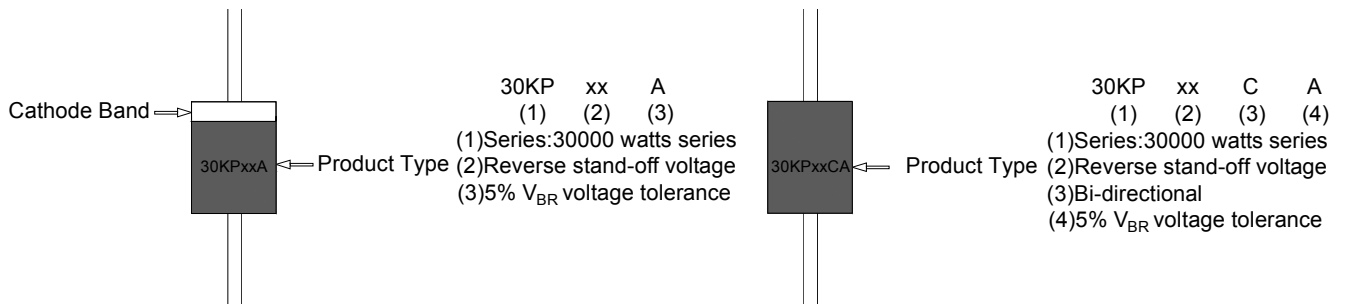

PACKAGE MECHANICAL DATA

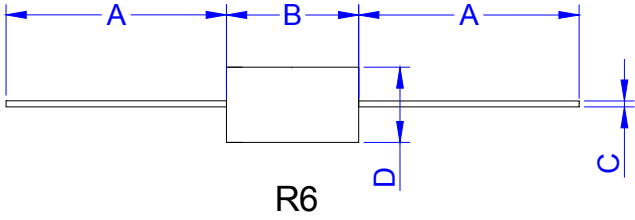
	Ref.	Dimensions			
		Millimeters		Inches	
		Min.	Max.	Min.	Max.
	A	25.40	-	1.000	-
B	8.60	9.40	0.339	0.370	
C	1.20	1.40	0.047	0.055	
D	8.60	9.10	0.339	0.358	

PART No.	UNIT WEIGHT (g/PCS) typ.	PER BOX (PCS)	PER CARTON (PCS)	DESCRIPTION
30KPxxA/CA	3.64	300	3,000	Box

Information furnished in this document is believed to be accurate and reliable. However, Jiangsu JieJie Microelectronics Co.,Ltd assumes no responsibility for the consequences of use without consideration for such information nor use beyond it.

Information mentioned in this document is subject to change without notice, apart from that when an agreement is signed, Jiangsu JieJie complies with the agreement.

Products and information provided in this document have no infringement of patents. Jiangsu JieJie assumes no responsibility for any infringement of other rights of third parties which may result from the use of such products and information.

This document is the 2.5th version which is made in 2-Aug.-2021. This document supersedes and replaces all information previously supplied.

 is a registered trademark of Jiangsu JieJie Microelectronics Co.,Ltd.

Copyright©2021 Jiangsu JieJie Microelectronics Co.,Ltd. Printed All rights reserved.